



CATÁLOGO

---

**FERRETERÍA**



# EL ESCUERZO

FABRICA ARGENTINA DE PITONES



## PITÓN C/ TOPE P/ TARUGO

### ABIERTO

<b>EPA04</b>	DE 4	100
<b>EPA05</b>	DE 5	50
<b>EPA06</b>	DE 6	50
<b>EPA08</b>	DE 8	50
<b>EPA10</b>	DE 10	25
<b>EPA12</b>	DE 12	20



### CERRADO

<b>EPC04</b>	DE 4	100
<b>EPC05</b>	DE 5	50
<b>EPC06</b>	DE 6	50
<b>EPC08</b>	DE 8	50
<b>EPC10</b>	DE 10	25
<b>EPC12</b>	DE 12	20



### ESCUADRA

<b>EPE04</b>	DE 4	100
<b>EPE05</b>	DE 5	50
<b>EPE06</b>	DE 6	50
<b>EPE08</b>	DE 8	50
<b>EPE10</b>	DE 10	25
<b>EPE12</b>	DE 12	20

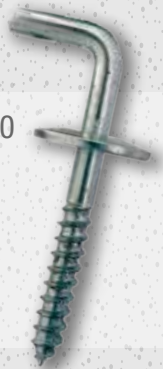

## PITÓN BRONCEADO C/ TOPE

### ABIERTO

<b>EBA35</b>	16-35	200
<b>EBA40</b>	17-40	200
<b>EBA45</b>	18-45	100
<b>EBA50</b>	19-50	100



### ESCUADRA

<b>EBE35</b>	16-35	200
<b>EBE40</b>	17-40	200
<b>EBE45</b>	18-45	100
<b>EBE50</b>	19-50	100



## PITÓN P/ MADERA

### ABIERTO

<b>EMA30</b>	16-30	200
<b>EMA40</b>	17-40	200
<b>EMA50</b>	19-50	100
<b>EMA60</b>	21-60	100
<b>EMA70</b>	21-70	100
<b>EMA80</b>	23-80	50



### CERRADO

<b>EMC30</b>	16-30	200
<b>EMC40</b>	18-40	100
<b>EMC50</b>	19-50	100
<b>EMC60</b>	21-60	100
<b>EMC70</b>	21-70	100
<b>EMC80</b>	23-80	50



### ESCUADRA

<b>EME30</b>	16-30	200
<b>EME40</b>	17-40	200
<b>EME50</b>	19-50	100
<b>EME60</b>	21-60	100
<b>EME70</b>	21-70	100
<b>EME80</b>	23-80	50



## PITÓN C/ TUERCA

### ABIERTO

<b>EAT50</b>	3,97x50	50
<b>EAT60</b>	4.76x60	50
<b>EAT70</b>	4.76x70	50
<b>EAT80</b>	6.35x80	25
<b>EAT90</b>	6.35x90	25
<b>EAT100</b>	7.94x100	25

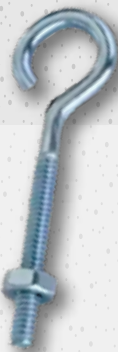

### CERRADO

<b>ECT50</b>	3,97x50	50
<b>ECT60</b>	4.76x60	50
<b>ECT70</b>	4.76x70	50
<b>ECT80</b>	4.76x80	50
<b>ECT90</b>	6.35x90	25
<b>ECT100</b>	7.94x100	25



### ESCUADRA

<b>EET50</b>	3,97x50	50
<b>EET60</b>	4.76x60	50
<b>EET80</b>	6.35x80	25
<b>EET100</b>	7.94x100	25





# EL ESCUERZO

FABRICA ARGENTINA DE PIONES



## CLAVO ACERO GALVANIZADO

<b>ECA1720</b>	1,7x20	400		<b>ECA2540</b>	2.5x40	200
<b>ECA2025</b>	2.0x25	200	CAJA X	<b>ECA3030</b>	3.0x30	100
<b>ECA2030</b>	2.0x30	200		<b>ECA3040</b>	3.0x40	100
<b>ECA2525</b>	2.5x25	200		<b>ECA3050</b>	3.0x50	100
<b>ECA2530</b>	2.5x30	200		<b>ECA3060</b>	3.0x60	100



## TENSOR GALVANIZADO

<b>ETG50</b>	50MM	10
<b>ETG60</b>	60MM	10
<b>ETG80</b>	80MM	10
<b>ETG100</b>	100MM	10

CAJA X



## PRENSA DE CALAR

<b>EPC50</b>	50MM	6
<b>EPC75</b>	75MM	6
<b>EPC100</b>	100MM	6

CAJA X



## RETÉN POSTIGO ZINCADO

<b>ERP90</b>	90MM	12
<b>ERP120</b>	120MM	12
<b>ERP160</b>	160MM	12

CAJA X



## GANCHO CONTRAVIENTO

<b>EGV30</b>	18-30	50
<b>EGV40</b>	18-40	50
<b>EGV50</b>	19-50	50
<b>EGV60</b>	19-60	50
<b>EGV70</b>	19-70	50
<b>EGV80</b>	21-80	50
<b>EGV90</b>	21-90	25

CAJA X





**SOPORTE BRACKET "404"**

CODIGO	COLOR	MM	EMPAQUE
<b>SC40401</b>	BLANCO	100 X 150	20
<b>SC40402</b>	BLANCO	150 X 200	20
<b>SC40403</b>	BLANCO	200 X 250	20
<b>SC40404</b>	BLANCO	250 X 300	20
<b>SC40405</b>	BLANCO	250 X 350	20
<b>SC40406</b>	NEGRO	100 X 150	20
<b>SC40407</b>	NEGRO	150 X 200	20
<b>SC40408</b>	NEGRO	200 X 250	20
<b>SC40409</b>	NEGRO	250 X 300	20
<b>SC40410</b>	NEGRO	250 X 350	20



**SOPORTE STRONG "405"**

CODIGO	COLOR	MM	EMPAQUE
<b>SC40501</b>	BLANCO	100 X 150	24
<b>SC40502</b>	BLANCO	150 X 200	24
<b>SC40503</b>	BLANCO	200 X 250	24
<b>SC40504</b>	BLANCO	250 X 300	24
<b>SC40505</b>	NEGRO	100 X 150	24
<b>SC40506</b>	NEGRO	150 X 200	24
<b>SC40507</b>	NEGRO	200 X 250	24
<b>SC40508</b>	NEGRO	250 X 300	24

**LANZAMIENTO**



**SOPORTE ESTANTE "422"**

CODIGO	COLOR	MM	EMPAQUE
<b>SC42201</b>	BLANCO	100 X 150	20
<b>SC42202</b>	BLANCO	150 X 200	20
<b>SC42203</b>	BLANCO	200 X 250	20
<b>SC42204</b>	BLANCO	250 X 300	20
<b>SC42205</b>	BLANCO	250 X 350	20
<b>SC42206</b>	NEGRO	100 X 150	20
<b>SC42207</b>	NEGRO	150 X 200	20
<b>SC42208</b>	NEGRO	200 X 250	20
<b>SC42209</b>	NEGRO	250 X 300	20
<b>SC42210</b>	NEGRO	250 X 350	20

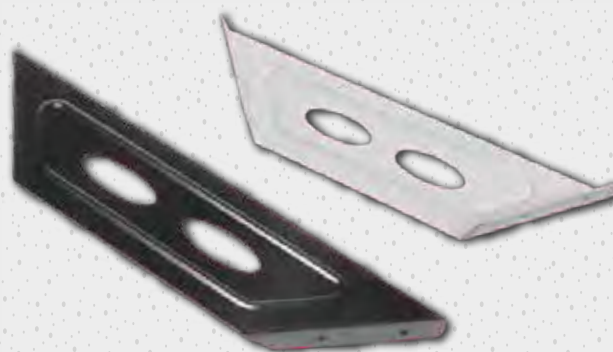

**SOPORTE LATERAL "401"**

CODIGO	COLOR	MM	EMPAQUE
<b>SC40101</b>	BLANCO	200	20
<b>SC40102</b>	BLANCO	300	20
<b>SC40103</b>	BLANCO	400	20
<b>SC40104</b>	NEGRO	200	20
<b>SC40105</b>	NEGRO	300	20
<b>SC40106</b>	NEGRO	400	20



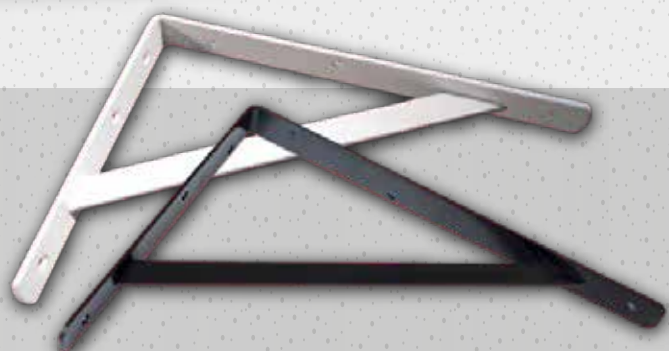

### SOPORTE TRAVESAÑO SUPER REFORZADO

CODIGO	COLOR	MM	EMPAQUE
<b>SC40301</b>	BLANCO	200 X 300	10
<b>SC40302</b>	BLANCO	250 X 400	10
<b>SC40303</b>	BLANCO	330 X 500	10
<b>SC40304</b>	NEGRO	200 X 300	10
<b>SC40305</b>	NEGRO	250 X 400	10
<b>SC40306</b>	NEGRO	330 X 500	10

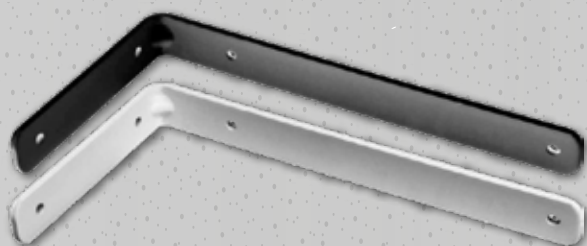

### SOPORTE FORTE

<b>SC41301</b>	BLANCO	100 X 150	20
<b>SC41302</b>	BLANCO	100 X 200	20
<b>SC41303</b>	BLANCO	100 X 250	20
<b>SC41304</b>	BLANCO	150 X 300	20
<b>SC41305</b>	NEGRO	100 X 150	20
<b>SC41306</b>	NEGRO	100 X 200	20
<b>SC41307</b>	NEGRO	100 X 250	20
<b>SC41308</b>	NEGRO	150 X 300	20



### SOPORTE GRANERO

<b>SC41401</b>	NEGRO	"U" 20 CM	10
<b>SC41402</b>	NEGRO	"U" 25 CM	10
<b>SC41403</b>	NEGRO	"Z" 20 CM	10
<b>SC41404</b>	NEGRO	"Z" 25 CM	10



**LANZAMIENTO**

**SOPORTE SPLIT 425**

VENTA POR PAR

MATERIAL ACERO 2 MM



CODIGO	COLOR	MEDIDA MM	CM	PARA EQUIPOS DE	EMPAQUE
<b>SC42501</b>	BLANCO	29X42	420	2000 A 4000 FG	8
<b>SC42502</b>	BLANCO	29X49	490	5000 A 8000 FG	8
<b>SC42505</b>	BLANCO	30X59	590	8000 A 10000 FG	6
<b>SC42503</b>	GALVANIZADO	29X42	420	2000 A 4000 FG	8
<b>SC42504</b>	GALVANIZADO	29X49	490	5000 A 8000 FG	8

**GANCHO HOOK 570**

VENTA POR PAR

**SC57001** KIT PACK X 2 UN. 1.4 X150X150 10 KP.



**SOPORTE VARILLA CHATA 430**

**SC43001**

MATERIAL EMPAQUE

ACERO 200  
0.9 MM

VENTA MÍNIMA

UF X 100 U



**SOPORTE REPISA 420**

REFERENCIA

MATERIAL

EMPAQUE

**SC42001**  
**SC42002**

ACERO  
1.60 MM

45  
75

100  
100

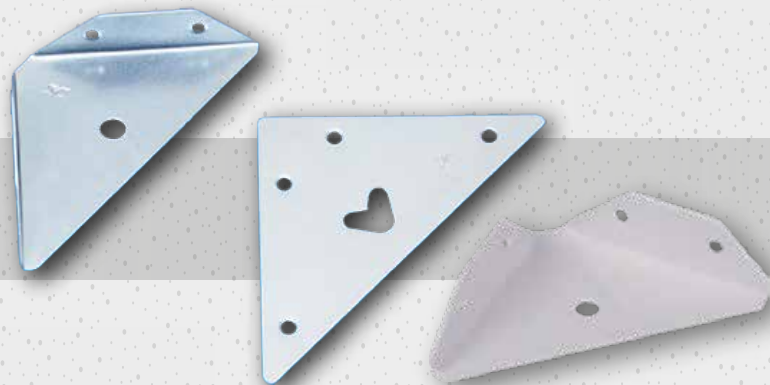

**SOPORTE ALACENA 410**

REFERENCIA

MATERIAL

EMPAQUE

**SC41001**  
**SC41002**  
**SC41003**

ÁNGULO  
PLANO  
ÁNGULO

ACERO 1.25 MM  
ACERO 1.25 MM  
COLOR BLANCO

12  
24  
12

### MÉNSULA DOBLE 406 Y 412

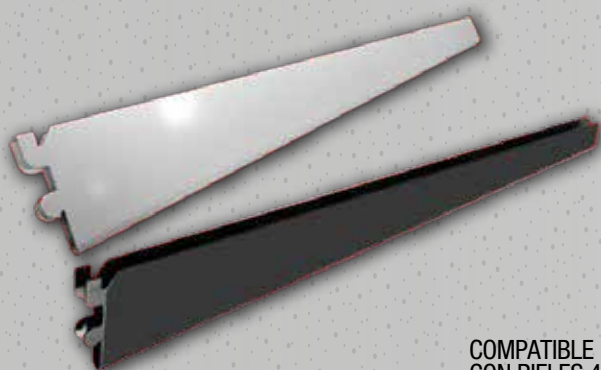

COMPATIBLE  
CON RIELES 406

REFERENCIA	COLOR	MM	EMPAQUE
<b>SC41201</b>	BLANCO	0,17	20
<b>SC41202</b>	BLANCO	0,27	20
<b>SC41203</b>	BLANCO	0,37	20
<b>SC40601</b>	BLANCO	0,47	12
<b>SC40602</b>	BLANCO	0,57	12
<b>SC41206</b>	NEGRO	0,17	20
<b>SC41207</b>	NEGRO	0,27	20
<b>SC41208</b>	NEGRO	0,37	20
<b>SC40603</b>	NEGRO	0,47	12
<b>SC40604</b>	NEGRO	0,57	12

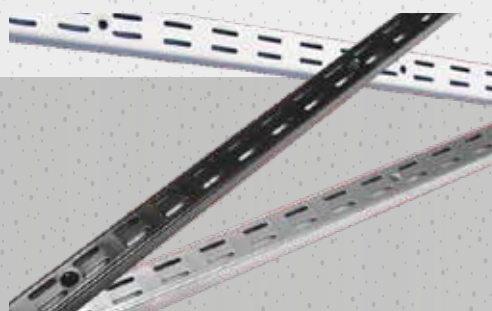

### RIEL DOBLE 406

<b>SC40605</b>	BLANCO	1,00	10
<b>SC40606</b>	BLANCO	1,50	10
<b>SC40607</b>	BLANCO	2,00	10
<b>SC40608</b>	NEGRO	1,00	10
<b>SC40609</b>	NEGRO	1,50	10
<b>SC40610</b>	NEGRO	2,00	10



INCLUYE 2 SOPORTES  
LATERALES Y FIJACIONES

ULTIMAS  
UNIDADES

### SET ESTANTE CON SOPORTE 605

<b>SC60501</b>	BLANCO	36 X 52	5
<b>SC60502</b>	BLANCO	40 X 60	5
<b>SC60503</b>	NEGRO	36 X 52	5
<b>SC60504</b>	NEGRO	40 X 60	5
<b>SC60505</b>	WENGUE	36 X 52	5
<b>SC60506</b>	WENGUE	40 X 60	5

DISCONTINUADO



INCLUYE SOPORTES  
Y FIJACIONES

### SET FLOTANTE 610

<b>SC61001</b>	BLANCO	80 X 25	5
<b>SC61002</b>	NEGRO	80 X 25	5

**LANZAMIENTO**



**SISTEMA MODULAR  
"METAL RACK" 320 NEGRO**

4 POSTES ENCASTRABLES ACERO NEGRO 1MM  
Y 5 ESTANTES PINTURA EPOXI BLANCO 0,5MM.

CODIGO	CM.	EMP.
<b>SC32047</b>	0.30X0.90X1.78	1

CAPACIDAD DE CARGA UNIFORME X ESTANTE



**SISTEMA MODULAR  
"MEGA RACK" 350 BLANCO**

4 POSTES ENCASTRABLES DE ACERO BLANCO 1.25 MM  
Y ESTANTES EN MDF 9 MM

CODIGO	PRESENTACIÓN	M	EMP.
<b>SC35001</b>	4 ESTANTES	0,80 X 0,35 X 1,50	1
<b>SC35002</b>	5 ESTANTES	0,80 X 0,35 X 1,80	1

CAPACIDAD DE CARGA UNIFORME X ESTANTE



**SISTEMA MODULAR  
"POWER RACK" 330 GRIS**

4 POSTES ENCASTRABLES DE ACERO GRIS 1.60 MM  
Y 5 ESTANTES EN MDF 12 MM

CODIGO	M	EMP.
<b>SC33001</b>	0,90 X 0,45 X 1,83	1

CAPACIDAD DE CARGA UNIFORME X ESTANTE



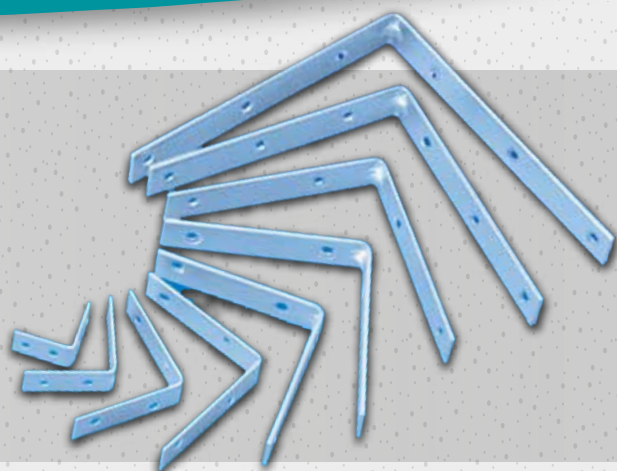

### ESQUINERO ANGULO 510

REFERENCIA	MATERIAL ACERO	MM	EMPAQUE
<b>SC51001</b>	1.80 MM.	25 X 25	24
<b>SC51002</b>	1.80 MM.	38 X 38	24
<b>SC51003</b>	2.00 MM.	50 X 50	24
<b>SC51004</b>	2.00 MM.	64 X 64	24
<b>SC51005</b>	2.50 MM.	76 X 76	12
<b>SC51006</b>	2.50 MM.	90 X 90	12
<b>SC51007</b>	2.50 MM.	100 X 100	12
<b>SC51008</b>	3.00 MM.	125 X 125	12
<b>SC51009</b>	3.00 MM.	150 X 150	12



### ESQUINERO ANGULO DOBLE 511

<b>SC51101</b>	1.80 MM.	35X35X38	24
<b>SC51102</b>	1.80 MM.	50X50X38	24
<b>SC51103</b>	1.80 MM.	65X65X38	24

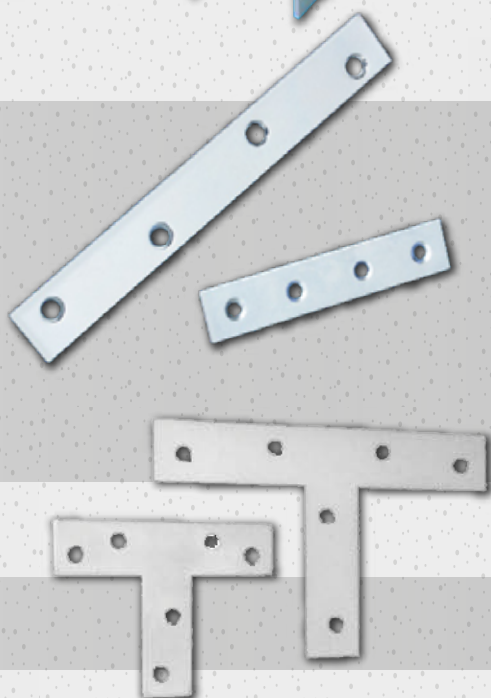

### PLANCHUELA UNIÓN 530

<b>SC53001</b>	1.80 MM.	50	24
<b>SC53002</b>	1.80 MM.	76	24
<b>SC53003</b>	2.00 MM.	100	24
<b>SC53004</b>	2.00 MM.	125	24
<b>SC53005</b>	2.50 MM.	150	24
<b>SC53006</b>	2.50 MM.	175	24
<b>SC53007</b>	2.50 MM.	200	24
<b>SC53008</b>	3.00 MM.	250	24
<b>SC53009</b>	3.00 MM.	300	24

### ESCUADRA T 540

<b>SC54001</b>	1.80 MM.	70 X 52	24
<b>SC54002</b>	1.80 MM.	120 X 73	24

### ESCUADRA PLANA CROMATIZADA 520

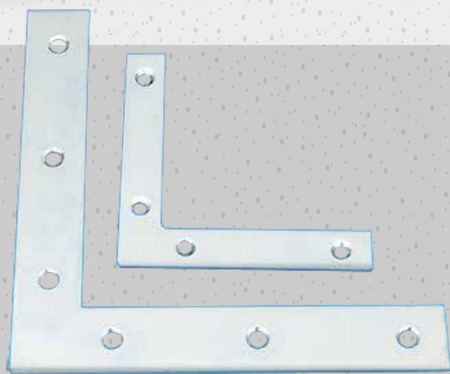

REFERENCIA	MATERIAL ACERO	MM	EMPAQUE
<b>SC52001</b>	1.6 MM	25 X 10	24
<b>SC52002</b>	1.6 MM	38 X 10	24
<b>SC52003</b>	1.6 MM	50 X 10	24
<b>SC52004</b>	1.6 MM	65 X 10	24
<b>SC52005</b>	1.8 MM	75 X 13	24
<b>SC52006</b>	1.8 MM	90 X 15	24
<b>SC52007</b>	2.0 MM	100 X 17	24
<b>SC52008</b>	2.0 MM	125 X 20	12
<b>SC52009</b>	2.0 MM	150 X 20	12



### GANCHOS PARA HAMACA 560

REFERENCIA	MATERIAL ACERO	MODELO	EMPAQUE
<b>SC56001</b>	1.6 MM, Ø 8	CON BASE	20
<b>SC56002</b>	1.6 MM, Ø 8	CON PITÓN	20
<b>SC56003</b>	1.6 MM, Ø 6	CON ARGOLLA	20

### GRAMPAS OMEGA Y 1/2 OMEGA 500

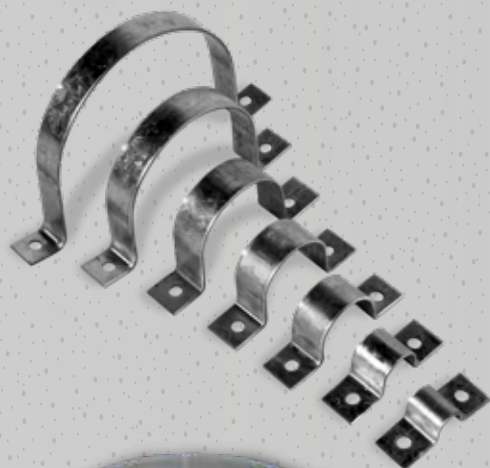

REFERENCIA	DESCRIPCIÓN	PULGADAS	EMPAQUE
<b>SC50001</b>	OMEGA	1/2"	200
<b>SC50002</b>	OMEGA	3/4"	200
<b>SC50003</b>	OMEGA	1"	200
<b>SC50004</b>	OMEGA	1 1/4"	200
<b>SC50005</b>	OMEGA	1 1/2"	100
<b>SC50006</b>	OMEGA	2"	100
<b>SC50007</b>	OMEGA	2 1/2"	50
<b>SC50008</b>	OMEGA	3"	50
<b>SC50009</b>	OMEGA	4"	50
<b>SC50010</b>	MEDIA OMEGA	1/2"	200
<b>SC50011</b>	MEDIA OMEGA	3/4"	200
<b>SC50012</b>	MEDIA OMEGA	1"	200
<b>SC50013</b>	MEDIA OMEGA	1 1/4"	200
<b>SC50014</b>	MEDIA OMEGA	1 1/2"	100
<b>SC50015</b>	MEDIA OMEGA	2"	100
<b>SC50016</b>	MEDIA OMEGA	2 1/2"	50

### CINTA MONTAJE 590

REFERENCIA	PRESENTACIÓN	FLEJE	EMPAQUE
<b>SC59001</b>	KIT PACK X 10M.	1.00 X 18 MM.	12

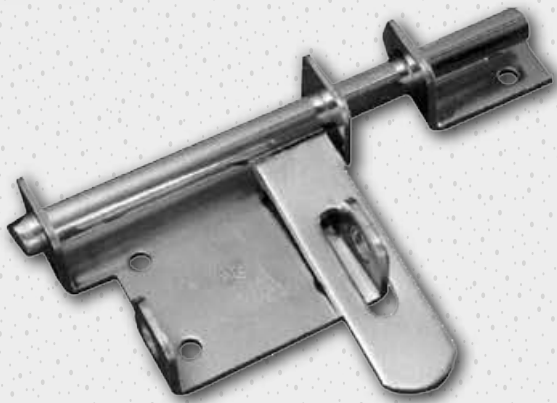

**PASADOR PORTA CANDADO CROMATIZADO 101**

REFERENCIA	ACERO	MM	EMPAQUE
<b>SC10101</b>	2.0 MM	100X48 Ø9	12
<b>SC10102</b>	2.5 MM	140X60 Ø11	6
<b>SC10103</b>	3.0 MM	170X75 Ø13	6



**PASADOR PISTOLETE 103**

REFERENCIA	ACERO	MM	EMPAQUE
<b>SC10301</b>	1.60 MM.	200X50 Ø12	6
<b>SC10302</b>	2.00 MM.	250X60 Ø14	6
<b>SC10303</b>	2.00 MM.	300X75 Ø16	6



**PASADOR MAUSER PORTA CANDADO CROMO 102**

REFERENCIA	ACERO	MM	EMPAQUE
<b>SC10201</b>	1.60 MM.	100X50 Ø12	6
<b>SC10202</b>	2.00 MM.	145X60 Ø14	6



**PASADOR MAUSER PORTA CANDADO NEGRO 102**

REFERENCIA	ACERO	MM	EMPAQUE
<b>SC10204</b>	1.6 MM	100X50 Ø12	6
<b>SC10205</b>	2.0 MM	145X60 Ø14	6

## PASADOR REDONDO TRABA RESORTE 107



REFERENCIA		MM	EMPAQUE
<b>SC10701</b>	CROMATIZADO	35 X 38	12
<b>SC10702</b>	CROMATIZADO	46 X 38	12
<b>SC10703</b>	CROMATIZADO	58 X 40	12
<b>SC10704</b>	CROMATIZADO	80 X 43	12
<b>SC10705</b>	BLANCO	35 X 38	12
<b>SC10706</b>	BLANCO	46 X 38	12
<b>SC10707</b>	BLANCO	58 X 40	12
<b>SC10708</b>	BLANCO	80 X 43	12
<b>SC10709</b>	NEGRO	35 X 38	12
<b>SC10710</b>	NEGRO	46 X 38	12
<b>SC10711</b>	NEGRO	58 X 40	12
<b>SC10712</b>	NEGRO	80 X 43	12

## LANZAMIENTO

## PASADOR CHATO TRABA RESORTE 108

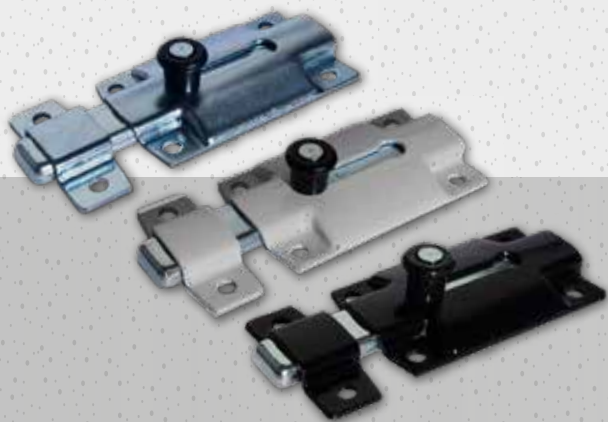

REFERENCIA	MM	EMPAQUE
<b>SC10801</b>	48 MM CROMADO	12
<b>SC10802</b>	72 MM CROMADO	12
<b>SC10803</b>	48 MM BLANCO	12
<b>SC10804</b>	72 MM BLANCO	12
<b>SC10805</b>	48 MM NEGRO	12
<b>SC10806</b>	72 MM NEGRO	12

## LANZAMIENTO

## MANIJA FIJA PULL 580 N° 1 25 X 160 MM



REFERENCIA		EMPAQUE
<b>SC58001</b>	BLANCA	20
<b>SC58002</b>	CROMADA	20
<b>SC58003</b>	NEGRA	20
<b>N°2 35 X 180 MM</b>		
<b>SC58005</b>	BLANCA	20
<b>SC58006</b>	CROMADA	20
<b>SC58007</b>	NEGRA	20

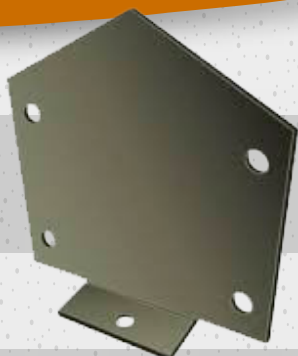

### CUMBRERA 513

REFERENCIA	MATERIAL ACERO	MM	EMPAQUE
SC51301	2.00 MM.	118X153X2	10
SC51302	2.00 MM.	145X183X2	10
SC51303	2.00 MM.	145X208X2	10



### CONECTOR ANGULO 514

SC51401	2.00 MM.	42X30X30	12
SC51402	2.00 MM.	67X30X30	12
SC51403	2.00 MM.	93X30X30	12
SC51404	2.00 MM.	117X30X30	12
SC51405	2.00 MM.	140X30X30	12
SC51406	2.00 MM.	165X30X30	12
SC51407	2.00 MM.	190X30X30	12
SC51408	2.00 MM.	215X35X35	12
SC51409	2.00 MM.	240X35X35	12
SC51410	2.00 MM.	290X35X35	12



### CONECTOR ANGULO IGUAL 515

SC51501	2.00 MM.	42X70X70	12
SC51502	2.00 MM.	67X70X70	12
SC51503	2.00 MM.	93X70X70	12
SC51504	2.00 MM.	117X94X94	12



### CONECTOR ANGULO DESIGUAL 516

SC51601	2.00 MM.	45X40X95	12
SC51602	2.00 MM.	65X44X117	12
SC51603	2.00 MM.	93X44X142	12
SC51604	2.00 MM.	117X70X142	12

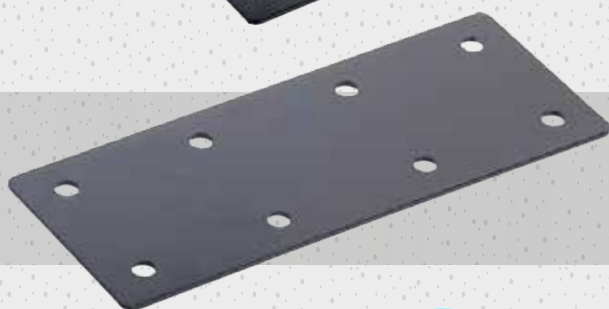

### CONECTOR PLACA 517

SC51701	2.00 MM.	42X124	12
SC51702	2.00 MM.	67X166	12
SC51703	2.00 MM.	93X200	12
SC51704	2.00 MM.	117X242	12

**CAJA DE FIJACIÓN ALETA INTERIOR 518  
SIN PERFORACIÓN LATERAL**

REFERENCIA	MATERIAL ACERO	MEDIDA	EMPAQUE
<b>SC51801</b>	1.40 MM.	2" X 4"	10
<b>SC51802</b>	1.40 MM.	2" X 5"	10
<b>SC51803</b>	1.40 MM.	2" X 6"	10

**CAJA DE FIJACIÓN ALETA INTERIOR 518  
CON PERFORACIÓN LATERAL**

<b>SC51804</b>	1.40 MM.	2" X 4"	10
<b>SC51805</b>	1.40 MM.	2" X 5"	10
<b>SC51806</b>	1.40 MM.	2" X 6"	10

**CAJA DE FIJACIÓN ALETA EXTERIOR 518  
SIN PERFORACIÓN LATERAL**

<b>SC51807</b>	1.40 MM.	2" X 4"	10
<b>SC51808</b>	1.40 MM.	2" X 5"	10
<b>SC51809</b>	1.40 MM.	2" X 6"	10

**CAJA DE FIJACIÓN ALETA EXTERIOR 518  
CON PERFORACIÓN LATERAL**

<b>SC51810</b>	1.40 MM.	2" X 4"	10
<b>SC51811</b>	1.40 MM.	2" X 5"	10
<b>SC51812</b>	1.40 MM.	2" X 6"	10

**CAJA FIJACIÓN ANGULO 30 519**

REFERENCIA	ACERO 2 MM	MEDIDA	EMPAQUE
<b>SC51901</b>	INFERIOR	2" X 4"	10
<b>SC51902</b>	INFERIOR	2" X 5"	10
<b>SC51903</b>	INFERIOR	2" X 6"	10
<b>SC51904</b>	SUPERIOR	2" X 4"	10
<b>SC51905</b>	SUPERIOR	2" X 5"	10
<b>SC51906</b>	SUPERIOR	2" X 6"	10

**CAJA AJUSTABLE 512**

<b>SC51244</b>	4'	10
<b>SC51245</b>	5'	10
<b>SC51246</b>	6'	10

## BISAGRAS



### ATORNILLAR

- CX150** 10 CM. X UD.
- CX151** 15 CM. X UD.
- CX152** 20 CM. X UD.
- CX153** 25 CM. X UD.
- CX154** 30 CM. X UD.

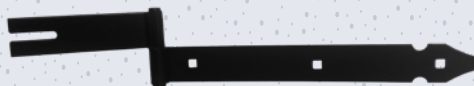

### AMURAR

- CX160** 10 CM. X UD.
- CX161** 15 CM. X UD.
- CX162** 20 CM. X UD.
- CX163** 25 CM. X UD.
- CX164** 30 CM. X UD.



### C/BULÓN P/ POSTE

- CX169** 10 CM. X UD.
- CX170** 15 CM. X UD.
- CX171** 20 CM. X UD.
- CX172** 25 CM. X UD.
- CX173** 30 CM. X UD.



### DOBLE

- CX179** 10 CM. X UD.
- CX180** 15 CM. X UD.
- CX181** 20 CM. X UD.
- CX182** 25 CM. X UD.



- CX192 CARROCERA  
ATORNILLAR  
X UD.**

## PASADORES



### CERROJO RECTO

- CX120** 15 CM. X UD.
- CX121** 20 CM. X UD.
- CX122** 25 CM. X UD.



### CERROJO CURVO

- CX123** 15 CM. X UD.
- CX124** 20 CM. X UD.
- CX125** 25 CM. X UD.



### PASADOR CHATO

- C/ PORTACANDADO X UD.**
- CX141** 10 CM.
- CX142** 15 CM.
- CX145** 20 CM.

## PASADORES



**PASADOR REDONDO**

**CX147** 20 CM. X UD.  
**CX143** 30 CM. X UD.



**CX144 PASADOR REDONDO  
PUNTERA P/ PISO  
X UD.**

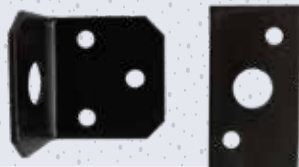

**CX191 PORTACANDADO  
PARA BAÚL X UD.**

## MÉNSULAS



**MÉNSULAS**

**CX201** 15 CM NEGRO X 12 UDS.  
**CX205** 20 CM NEGRO X 12 UDS.  
**CX209** 25 CM NEGRO X 12 UDS.  
**CX213** 30 CM NEGRO X 12 UDS.



**SOPORTE REFORZADO  
DER/IZQ. NEGRO**

**CX259** 30 CM. X PAR  
**CX260** 40 CM. X PAR  
**CX261** 50 CM. X PAR  
**CX262** 60 CM. X PAR

## ESCUADRAS

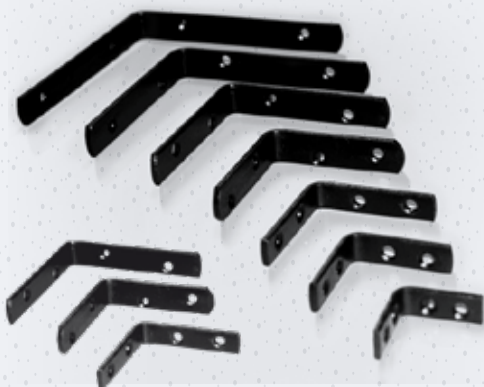

PRESENTACIÓN X 24 UDS

**ESCUADRA  
H° REVERSIBLE  
NEGRO**

**CX303** 3 X 3 CM.  
**CX304** 4 X 4 CM.  
**CX305** 5 X 5 CM.  
**CX306** 6 X 6 CM.  
**CX308** 8 X 8 CM.  
**CX310** 10 X 10 CM.  
**CX312** 12 X 12 CM.

## CAJAS

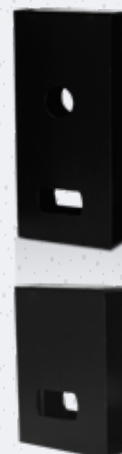

**CAJA P/ CERRADURA**

**CX110** P-208 Y SIMIL.  
72 X 156 X 25 X UD.  
**CX113** P-200 Y SIMIL.  
72 X 160 X 25 X UD.

**CX112 CAJA  
P/ CERROJO**

72 X 100 X 25 X UD.

**SOPORTES**



**SOPORTE P/ MANGUERA  
BLANCO**



**CX930** CHICO X UD  
**CX932** GRANDE X UD

**SOPORTE P/ MACETA  
NEGRO**

**CX245** 22 CM X UD.  
**CX247** 29 CM X UD

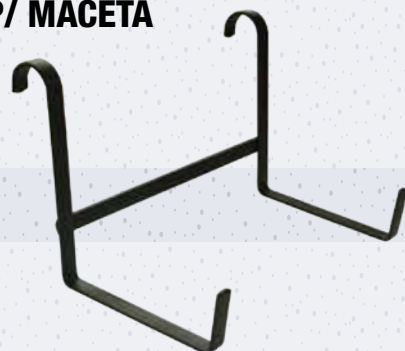

**CX336** SOPORTE P/ VIDRIO  
(CLARABOYA) BLANCO  
EPOXI X 4 UDS.



**CX503**  
**SUPER ANTORCHITA**  
X 12 UDS.



**RETENES**



**CX602** MULTIUSO  
EXHIBIDOR SURTIDO X 12 UDS.



**CX700** CUÑA  
TRABA PUERTA PVC



**CX702** RETEN PUERTA-PISO  
EXHIBIDOR SURTIDO X 12 UDS.



**CX709** RETEN PUERTA-PARED  
EXHIBIDOR SURTIDO X 12 UDS

## SOPORTES P/ ESPEJO



### FIJO

Cod.	Medidas	Espesor Espejo	Vta. Min.	Bulto X
<b>FU-X13/3</b>	13MM / 3 MM		25	100
<b>FU-X13</b>	13 MM / 4 MM		25	100
<b>FU-X14</b>	13 MM / 6 MM		25	100
<b>FU-X10/4</b>	19 MM / 4 MM		25	100
<b>FU-X10</b>	19 MM / 6 MM		25	100



### REFORZADO

Cod.	Medidas	Espesor Espejo	Vta. Min.	Bulto X
<b>FU-B55</b>	50MM / 6 MM		12	48



### CORREDIZO

Cod.	Medidas	Espesor Espejo	Vta. Min.	Bulto X
<b>FU-X13/3/C</b>	13MM / 3 MM		25	100
<b>FU-X13/C</b>	13 MM / 4 MM		25	100
<b>FU-X14/C</b>	13 MM / 6 MM		25	100
<b>FU-X10/4/C</b>	19 MM / 4 MM		25	100
<b>FU-X10/C</b>	19 MM / 6 MM		25	100

### SOPORTE Z



Cod.	Medidas	Ancho	Vta. Min.	Bulto X
<b>FU-X39</b>	3 MM X 10 MM		25	100
<b>FU-X36</b>	4 MM X 13 MM		25	100
<b>FU-X35</b>	6 MM X 13 MM		25	100
<b>FU-X33</b>	6 MM X 19 MM		25	100

FU-X39

FU-X36

FU-X35

FU-X33



FU-X24



FU-X25



FU-X22



FU-X18

## SOPORTE ESTANTE BASTIDOR

Cod.	Características y Medidas	Vta. Min.	Bulto X
<b>FU-X24</b>	ESTANTE 1,2 MM ESPESOR	25	100
<b>FU-X25</b>	BOTIQUÍN/BASTIDOR ANCHO 19 MM /1 AGUJERO	25	100
<b>FU-X22</b>	L ESTANTE/BASTIDOR 33MM X 14MM X 8.5MM	25	100
<b>FU-X18</b>	L ESTANTE/BASTIDOR ANCHO 13 MM / LARGO 22 MM	25	100



FU-X26P



FU-X26G



FU-X26J



FU-X26D



FU-X40

## SOPORTE DOBLE VIDRIO

Cod.	Características	Vta. Min.	Bulto X
<b>FU-X26P</b>	PEQUEÑO	25	100
<b>FU-X26G</b>	GRANDE	25	100
<b>FU-X26J</b>	DOBLE VIDRIO	25	100
<b>FU-X26D</b>	DOBLE ALA	25	100
<b>FU-X40</b>	CHAPA C/ AGUJERO	25	100



## SOPORTE ESTANTE CILINDRICO

Cod.	Medidas	Vta. Min.	Bulto X
<b>FU-X27P</b>	DIAM.15 ESTANTE 6MM	1	20



## PERCHA P/ MAMPARA BAÑO

Cod.	Medidas	Vta. Min.	Bulto X
<b>FU-XPM</b>	7.5 CM	2	12

## SOPORTES



FU-X53



FU-X356



FU-XCL

## P/ CUADROS COLGANTE

Cod.	Características y Medidas	Vta. Min.	Bulto X
<b>FU-X53</b>	LARGO 53 MM ESPESOR 1,2 MM ANCHO 13 MM	25	100
<b>FU-X356</b>	PORTARRETRATO	25	100
<b>FU-XCL</b>	PORTARRETRATO	25	100



FU-B7



FU-B78



FU-X8INOX



FU-X8AL

## ESQUINEROS

Cod.	Medidas	Vta. Min.	Bulto X
<b>FU-B7</b>	30 X 30 X 19 MM C/ TAPA1	24	48
<b>FU-B78</b>	40 X 40 X 22 MM CON FORMA	12	48
<b>FU-X8INOX</b>	13 MM ALTURA	25	100
<b>FU-X8AL</b>	AL 13 MM DE ALTURA	25	100

## SOPORTE CAÑO OVAL



Cod.	Medidas	Vta. Min.	Bulto X
<b>FU-SCO</b>	16 MM	12	48

## EMBELLECEDORES

### BRONCE PLATIL

Cod.	Características	Vta. Min.	Bulto X
<b>FU-E12</b>	Ø 12MM	1	24
<b>FU-E16</b>	Ø 16MM	1	24
<b>FU-E18</b>	Ø 18MM	1	24
<b>FU-E21</b>	Ø 21MM	1	24





## KIT COMPLETO P/CORTINA

Cod. Características y Medidas Vta. Min. Bulto X

**FU-XTCKIT** DE BAÑO 2.5 M 1 1

Incluye: 2 FU-XTC (tensor para cable) , 2.5 m cable acero 2 mm, 12 FU-GK (gancho cortina), llave allen, tarugos y tornillos.



Cod. Características y Medidas Vta. Min. Bulto X

**FU-XTZKIT** 3.5 M 1 1

Incluye: 2 FU-XTC (tensor para cable), 3.5 m cable acero de 2 mm, 2 FU-XTZS (Soporte Z), 1 FU-XTZL (soporte L) , llave allen, tarugos y tornillos.



## SOPORTE Z

P/ CABLE CORTINA 2 MM

Cod. Vta. Min. Bulto X

**FU-XTZS** 4 12



## SOPORTE L

P/ CABLE CORTINA 2 MM

Cod. Vta. Min. Bulto X

**FU-XTZL** 4 12



## TENSOR

P/ CABLE CORTINA 2 MM

Cod. Vta. Min. Bulto X

**FU-XTC** 1 4



## GANCHO

P/ CABLE CORTINA

Cod. Vta. Min. Bulto X

**FU-GK** 12 48

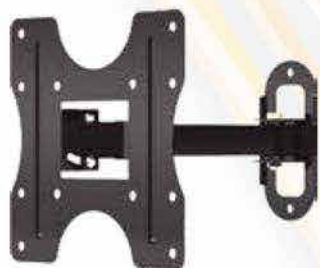

**ES-EB140**  
SOPORTE 1 BRAZO DE  
MOVIMIENTO COMPLETO  
de 23" a 42"

Inclinación -20°+20°  
Giro 180°  
Distancia 100-250 mm  
Medidas VESA 200x200  
Capacidad 25 kg



**ES-EB040**  
SOPORTE FIJO  
BASCULANTE  
de 23" a 42"

Inclinación -20°+20°  
Giro 30°  
Distancia 85 mm  
Medidas VESA 200x200  
Capacidad 30 kg

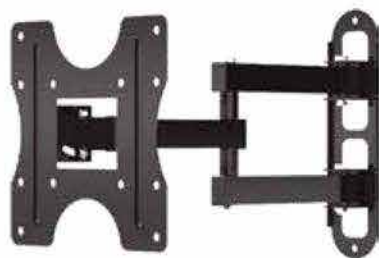

**ES-EB240**  
SOPORTE 2 BRAZOS DE  
MOVIMIENTO COMPLETO  
de 23" a 42"

Inclinación -20°+20°  
Giro 180°  
Distancia 100-450 mm  
Medidas VESA 200x200  
Capacidad 30 kg



**ES-EF40**  
SOPORTE FIJO  
ULTRACHATO  
de 23" a 42"

Distancia 20 mm  
Medidas VESA 200x200  
Capacidad 30 Kg.



**SISTEMA DE EXTENSIÓN**

Cualquier soporte con norma VESA 200x200 (hasta 42") se le agregan extensores (ES-SA400) logrando la norma Vesa 400 x 400 ( hasta 55")

**ES-SA400**



**EXHI-LCOS**  
PIE KIT EXHIBIDOR  
CON 4 MODELOS  
DE SOPORTES

**BENEFICIOS:**

- Disminución del 50 % de stock en modelos.
- Menor costo.
- Simplicidad en la venta
- Mayor margen de ganancia con excelente precio al público.



### Soporte para TV

**ES-EF80**  
SOPORTE  
LCD FIJO  
T/ MENSULA  
H. 65'



**Brazo móvil simple p/**  
▪ LED  
▪ Televisores LCD  
▪ Pantallas

**ES-E180**  
SOPORTE LCD  
BASCULANTE  
T/ MENSULA H. 65'



**Brazo móvil simple p/**  
▪ LED  
▪ Televisores LCD  
▪ Pantallas

**ES-EB180**  
SOPORTE LCD 1  
BRAZO SIMPLE  
T/ MENSULA  
HASTA 65'



**Brazo móvil doble p/**  
▪ LED  
▪ Televisores LCD  
▪ Pantallas

**ES-EB280**  
SOPORTE LCD  
2 BRAZOS REF.  
T/ MENSULA  
HASTA 65'



**Brazo móvil doble p/**  
▪ LED  
▪ Televisores LCD  
▪ Pantallas

**ES-EB300**  
SOPORTE LCD 2  
BRAZOS REF. PREMIUM  
T/ MENSULA H.65

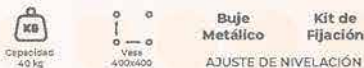



### BISAGRA FICHA REVERSIBLE HIERRO ZINCADO

#### PLATEADO

Código	Descripción	CAJA X
<b>TB0120</b>	A 2 X3 X1.5 (X UD)	24
<b>TB120G</b>	A 2 X3 X1.5 (GRANEL)	100
<b>TB0121</b>	A 2 X5 X1.5 (X UD)	24



### BISAGRA MUNICIÓN CON AGUJEROS

<b>TB0160</b>	75X75 (3X3') X UD.	12
<b>TB0161</b>	101X75 (4X3') X UD.	12
<b>TB0162</b>	101X88 (4X3 1/2') X UD	12

### BISAGRA "T" HIERRO PULIDO

<b>TB9601</b>	76 MM (3.0") X DCP	1 DCPS
<b>TB9602</b>	101 MM (4.0") X DCP	1 DCPS
<b>TB9603</b>	127 MM (5.0") X DCP	1 DCPS
<b>TB9604</b>	152 MM (6.0") X DCP	1 DCPS
<b>TB9605</b>	202 MM (8.0") X DCP	1 DCPS



### BISAGRA 5005 HIERRO

BRONCEADO			PULIDO		
<b>TB9800</b>	19 MM (3/4') DCP	5 DCPS	<b>TB9500</b>	19 MM (3/4') DCP	5 DCPS
<b>TB9801</b>	25 MM (1.0') DCP	2 DCPS	<b>TB9501</b>	25 MM (1.0') DCP	2 DCPS
<b>TB9802</b>	38 MM (1.5') DCP	1 DCPS	<b>TB9502</b>	38 MM (1.5') DCP	1 DCPS
<b>TB9803</b>	51 MM (2.0') DCP	1 DCPS	<b>TB9503</b>	51 MM (2.0') DCP	1 DCPS
<b>TB9804</b>	63 MM (2.5') DCP	1 DCPS	<b>TB9504</b>	63 MM (2.5') DCP	1 DCPS
<b>TB9805</b>	76 MM (3.0') DCP	1 DCPS	<b>TB9505</b>	76 MM (3.0') DCP	1 DCPS
<b>TB9806</b>	89 MM (3.5') DCP	1 DCPS	<b>TB9506</b>	89 MM (3.5') DCP	1 DCPS
<b>TB9807</b>	101 MM (4.0') DCP	1 DCPS	<b>TB9507</b>	101 MM (4.0') DCP	1 DCPS



### BISAGRA 1842 ZINCADO

<b>TF1000</b>	51 MM AMARILLO (X UD)	25	<b>TF1001</b>	51 MM AZUL (X UD)	25
<b>TF1002</b>	63 MM AMARILLO (X UD)	25	<b>TF1003</b>	63 MM AZUL (X UD)	25



### BISAGRAS POMELAS

<b>TB0112D</b>	DERECHA 140X70 X UD.	12 o 25	<b>TB1012D</b>	DERECHA 140X70 X UD.	12 o 25
<b>TB0112I</b>	IZQUIERDA 140X70 X UD.	12 o 25	<b>TB1012I</b>	IZQUIERDA 140X70 X UD.	12 o 25
<b>CARPINTERÍA</b>			<b>MIXTA</b>		



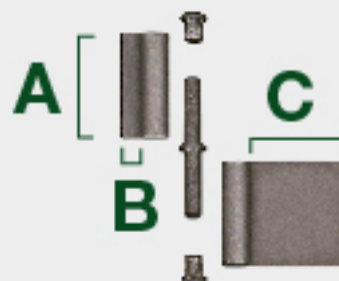
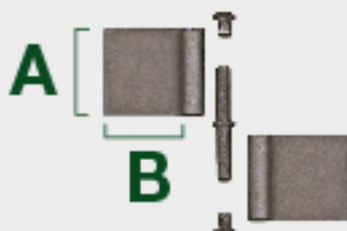

### BISAGRA FICHA REVERSIBLE HERRERO HIERRO PULIDO

Código	Descripción	CAJA X	Código	Descripción	CAJA X	Código	Descripción	CAJA X
TB2022	A60XB8 (X UD)	24	TB2025	A60XB33 (X UD)	24	TB2028	A60XB8XC33 (X UD)	24
TB2023	A80XB8 (X UD)	24	TB2026	A80XB33 (X UD)	24	TB2029	A80XB8XC33 (X UD)	24
TB2024	A100XB8 (X UD)	24	TB2027	A100XB33 (X UD)	24	TB2030	A100XB8XC33 (X UD)	24
ALA CORTA			ALA LARGA			ALA CORTA y LARGA		



### BISAGRA TIPO MUNICIÓN HERRERO HIERRO PULIDO

Código	Descripción	CAJA X	Código	Descripción	CAJA X	Código	Descripción	CAJA X
TB2067	75X44 (3X13/4") X UD.	12	TB2061	101X75 (4X3") X UD	12	TB1060	75X75 (3X3") X UD	12
TB2066	101X44 (4X13/4") X UD.	12	TB2062	101X88 (4X31/2") X UD.	12	TB1061	101X75 4x3 X UD	12
TB2060	75X75 (3X3") X UD.	12				TB1062	101X88 (4X31/2") x UD	12
ALA CORTA			ALA LARGA			MIXTA		



TB9701	BISAGRA D. ACCION CHAROLADA 73 MM (3.0") EL PAR	1 PAR
TB0150	BISAGRA MOSQUERA HRO. ZINC AZUL 64 MM X UD	12

TB8501	CIERRA PTA. A RODILLO ZINCADO X UD (10 UD/C)	10
TB1410	RETÉN A RODILLO HRO. ZINC. 32 MM X UD	100
TB1411	RETÉN MAGNÉTICO PVC BLANCO 36 MM X UD.	100



**T**rapano

**tärken**  
QUALITY METALWORKS

**BRONZEN**®

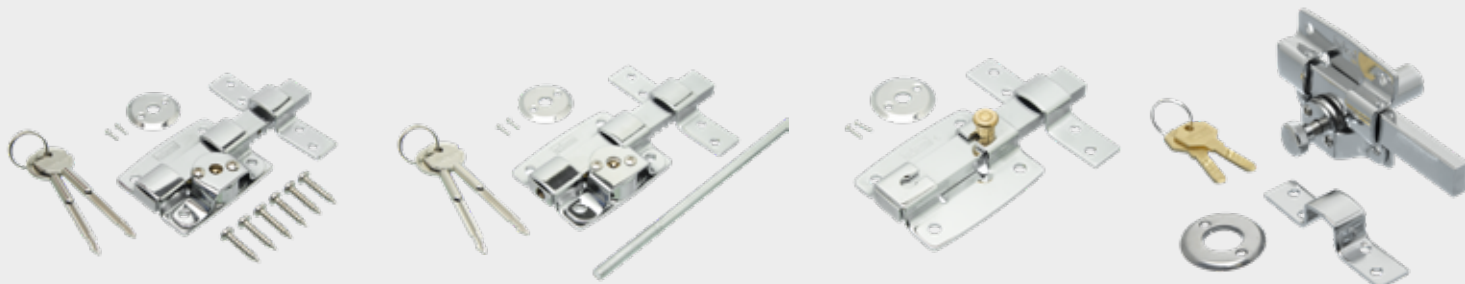

### PASADOR CERROJO

CAJA X

<b>BN805</b>	LLAVE CRUZ	20
<b>BN805C</b>	LLAVE CRUZ = COMBINACION	20
<b>BN805V</b>	LLAVE CRUZ C/ PERNO VERTICAL	20

CAJA X

<b>BN810</b>	CROMADO A GATILLO	20
<b>BN815</b>	CROMADO LLAVE COMPUTADA	20
<b>BN815C</b>	CROMADO LL. COMP. = COMB.	20



### BISAGRA CAZOLETA

CAJA X

<b>BN145-0</b>	26 MM CODO 0	200
<b>BN150-0</b>	35 MM CODO 0	200
<b>BN145-9</b>	26 MM CODO 9	200
<b>BN150-9</b>	35 MM CODO 9	200



### BRAZO CIERRAPUERTA HIDRAULICO

<b>BN1560</b>	H. 60 KG	CAJA X 10
<b>BN1580</b>	H. 80 KG	CAJA X 10



### MANIJA PARA BAUL

Código	Descripción	CAJA X
<b>TB0110</b>	80 X 70 ZINC. AZUL X UD.	24
<b>TB0210</b>	80 X 70 ZINC. NEGRO X UD.	24

### MANIJA FIJA LIVIANA

<b>TB1101</b>	3' X DOC.	12
<b>TB1102</b>	4' X DOC.	12
<b>TB1103</b>	5' X DOC.	12
<b>TB1104</b>	6' X DOC.	12



### CADENA DE SEGURIDAD

<b>TB7202</b>	90 X 36 HRO. BDO.	20
<b>TB7201</b>	90 X 36 HRO. NIQ.	20

### PASADOR CERROJO CHAROLADO

<b>TB8901</b>	38 MM (1.5') X DOC.	12
<b>TB8902</b>	51 MM (2.0') X DOC.	12



### RUEDAS DUALES



**C/INSERTO**  
PRESENTACION CAJA X 4



**C/BASE**  
PRESENTACION CAJA X 4



**C/ROSCA**  
PRESENTACION CAJA X 4



**ENCASTRE U**  
PRESENTACION CAJA X 4

**TB1801** 40 MM (1 5/8") X UD.  
**TB1802** 50 MM (2") X UD.

**TB1302** 50MM (2") X UD.  
**TB1301** 40MM (1 5/8") X UD

**TB1403** 40 MM (1 5/8") 5/16 X UD.  
**TB1401** 40MM (1 5/8") 1/4" X UD.  
**TB1404** 50 MM (2") 5/16 X UD.  
**TB1402** 50MM (2") 1/4" X UD.

**TB1903** 40 MM (1 5/8") 19 MM X UD  
**TB1901** 40MM (1 5/8") 16MM X UD.  
**TB1902** 50 MM (2") 16 MM X UD.  
**TB1904** 50MM (2") 19MM X UD.



#### RUEDA GOMA NEGRA B. GIRAT.

**BN001** 25 MM  
**BN002** 32 MM  
**BN003** 40 MM  
**BN003F** 40 MM C/ FRENO  
**BN004** 50 MM  
**BN004F** 50 MM C/ FRENO

#### RUEDA CRISTAL ROLLER

**BN005** 50 MM.  
**BN005F** 50 MM C/ FRENO

#### RUEDA GOMA GRIS

**BN006** 50 MM  
**BN006F** C/ FRENO 50 MM  
**BN007** 75 MM  
**BN007F** C/ FRENO 75 MM  
**BN008** 100 MM  
**BN008F** C/ FRENO 100 MM



#### RUEDA NYLON NGA. BASE FJA

**BN011** 25 MM  
**BN012** 30 MM  
**BN013** 40 MM  
**BN014** 50 MM

#### RUEDA NYLON NGA. BASE G.

**BN009** 35 MM  
**BN009F** 35 MM C/ FRENO  
**BN010** 50 MM  
**BN010F** 50 MM C/ FRENO

#### RUEDA NYLON BCA. GIRATORIA

**BN015** 50 MM  
**BN015F** 50 MM C/ FRENO  
**BN016** 75 MM  
**BN016F** 75 MM C/ FRENO



### RUEDA CHAPA Y GOMA NEGRA

**BN017** FIJA 75 MM  
**BN017G** GIRATORIA 75 MM  
**BN017F** GIRAT. 75 MM C/FRENO  
**BN018** FIJA 100 MM  
**BN018G** GIRATORIA 100 MM  
**BN018F** GIRAT. 100 MM C/FRENO



**BN019** FIJA 125 MM  
**BN019G** GIRATORIA 125 MM  
**BN019F** GIR. 125 MM C/FRENO



### RUEDA POLIPROP. BLANCA



**BN022** 75 MM FIJA  
**BN022G** 75 MM GIRATORIA  
**BN022F** 75 MM GIRAT. C/FRENO  
**BN023** 100 MM FIJA  
**BN023G** 100 MM GIRATORIA

**BN023F** 100 MM GIRAT. C/FRENO  
**BN024** 125 MM FIJA  
**BN024G** 125 MM GIRATORIA  
**BN024F** 125 MM GIRAT. C/FRENO



### RUEDA ANDAMIO GIRATORIA



**BN020** 160MM CAÑO 54 MM  
**BN021** 160MM CAÑO 54 MM C/FRENO

### RUEDA PP/PVC CAUCHO C/RUL



**BN027** 75 MM FIJA  
**BN027G** 75 MM GIRATORIA  
**BN027F** 75 MM GIRAT. C/FRENO  
**BN028** 100 MM FIJA  
**BN028G** 100 MM GIRATORIA

**BN028F** 100 MM GIRAT. C/FRENO  
**BN029** 125 MM FIJA  
**BN029G** 125 MM GIRATORIA  
**BN029F** 125 MM GIRAT. C/FRENO



### RUEDA PP/ POLIURETANO C/RUL.



**BN025** 100 MM FIJA  
**BN025G** 100 MM GIRAT.  
**BN025F** 100 MM GIRAT. C/FRENO

**BN026** 125 MM FIJA  
**BN026G** 125 MM GIRAT.  
**BN026F** 125 MM GIRAT. C/FRENO

# TENDERS DE PIE

**MOR** FS METALURGICA  
BRONZEN®  Politen

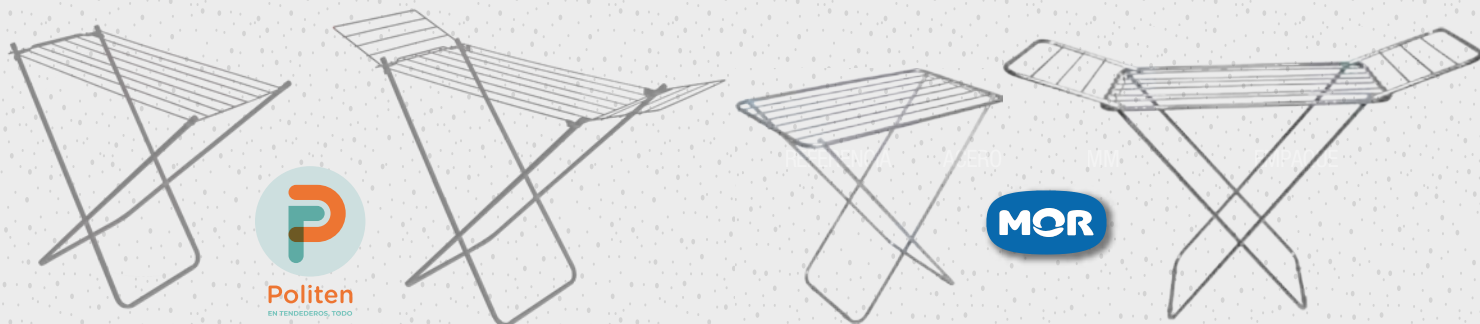

## EPOXI

- TP1001 8 VAR.
- TP1002 8 VAR. C/ ALAS
- TP1003 9 VAR.
- TP1004 9 VAR. C/ ALAS

## ALUMINIO

- TP2001 SLIM 6 VARILLAS.
- TP2002 SLIM C/ALAS 6 VAR.
- TP2003 REF. C/ALAS 6 VAR.

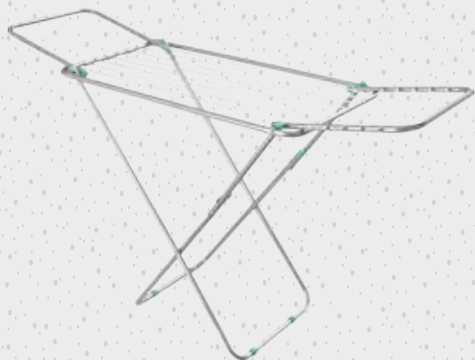

## ALUMINIO C/ SOGA

TP2004 8 SOGAS CON ALAS



## INOXIDABLE VERTICAL

TP3001  
3 PISOS C/RUEDA



## LANZAMIENTO

## TENDER CALESITA

TC1004 GIRATORIO  
BASE CEMENTO



# TENDERS

EXTENSIBLES  
y SOPORTE

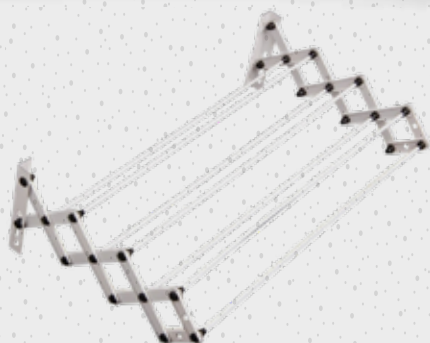

## REF. EPOXI 7 VARILLAS

- TE1001 45 CM
- TE1002 60 CM
- TE1003 80 CM
- TE1004 100 CM



## LANZAMIENTO

## ALUMINIO 7 VARILLAS

- TE2001 80 CM
- TE2002 100 CM
- TE2003 120 CM

## EXTENSIBLES BRONZEN®

### LANZAMIENTO



- TE3001
- 1 LINEA PVC GRIS 12 M.

### LANZAMIENTO



- TE3002
- 1 LINEA A. INOX 2.8 M

### LANZAMIENTO



- TE3003
- 5 LINEAS 3.75 M



## SOPORTE BICICLETA

- SP2014
- EPOXI NEGRO FS.

FS METALURGICA



## REGLA DE ALISADO PARA ALBAÑILERÍA

Aluminio templado, regatones plásticos extraíbles para facilitar su llenado a la hora de alisar pisos y su vaciado para paredes. Angulos perfectos

Cod.	Medidas	Uds x paq.
<b>RA0150</b>	150 CM	12
<b>RA0200</b>	200 CM	12
<b>RA0300</b>	300 CM	6

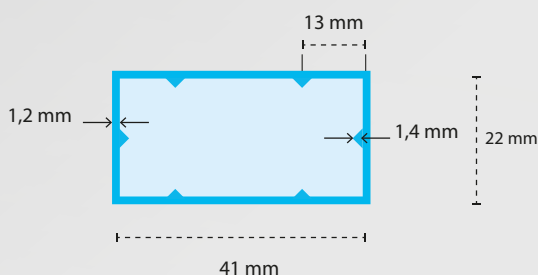

## REGLA PARA YESERO

Aluminio templado, regatones plásticos. Ideal para el pintor y el yesero

Cod.	Medidas	Uds x caja
<b>RY0065</b>	65 CM	6
<b>RY0130</b>	130 CM	6
<b>RY0200</b>	200 CM	6
<b>RY0260</b>	260 CM	6

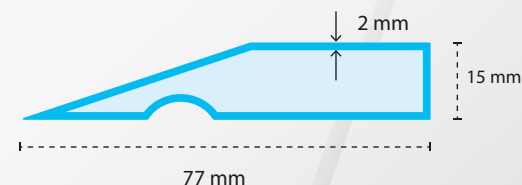



## ZÓCALOS DE ALUMINIO

Aluminio templado y goma virgen extrusada

Cod.	Medidas	Ud. vta.	Uds x paq.
<b>ZA0070</b>	70 CM	1	50
<b>ZA0080</b>	80 CM	1	50
<b>ZA0090</b>	90 CM	1	50
<b>ZA0100</b>	100 CM	1	50

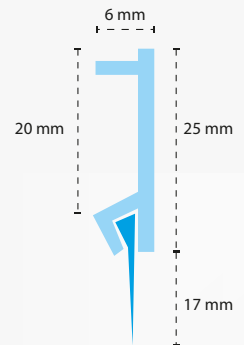
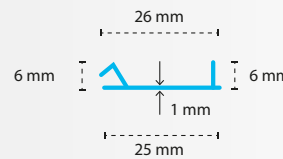

## ZÓCALOS DE PVC

Autoadhesivos, goma y pvc virgen extrusados



CRISTAL



MARRÓN



NEGRO



BLANCO

Cod.	Medidas	Color	Ud. vta.	Uds x paq.
<b>ZGB100</b>	100 CM	BLANCO	1	50
<b>ZGC100</b>	100 CM	CRISTAL	1	50
<b>ZGM100</b>	100 CM	MARRÓN	1	50
<b>ZGN100</b>	100 CM	NEGRO	1	50

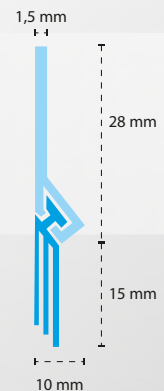

## TOPES PARA PUERTA

Diseño unico. Material flexible con memoria

Cod.	Color	Ud. vta.	Uds x paq.
<b>TP1000</b>	SURTIDOS	1 CAJA	24 TOPES
<b>TP1105</b>	BLANCO	1	100
<b>TP1100</b>	CRISTAL	1	100
<b>TP1115</b>	MARRÓN	1	100
<b>TP1110</b>	NEGRO	1	100

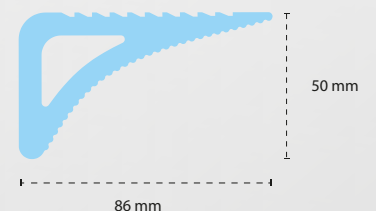

BLANCO



CRISTAL



MARRÓN



NEGRO

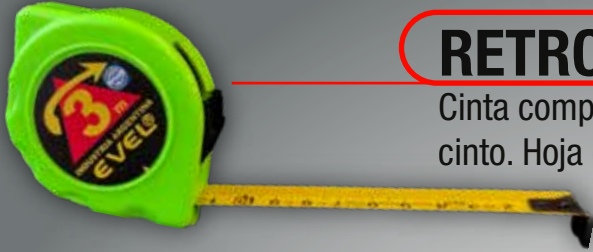

## RETROBLOCK

Cinta compacta, carcasa plástica de A.B.S, con enganche para cinto. Hoja de acero de gran resistencia. Automática con freno



## PREMIUMBLOCK

Cinta compacta con revestimiento UV, Modelo ergonómico con carcasa plástica de A.B.S alto impacto, enganche para cinto. Hoja de acero de gran resistencia. Automática con freno de acción positiva. Correa pasamano y puntera zamac corrediza con 3 remaches.



## STANDAR ACERO

Cinta de acero niquelado enrollable, carcasa plástica de A.B.S, enrollador de NYLON, hoja de acero de gran resistencia. Blister individual.



## AGRIMENSOR

Hoja de acero esmaltado amarillo con carcasa A.B.S y enrollador de NYLON para mayor fluidez al enrollar.

## METROS PLÁSTICOS

Plegables de alto impacto, con mecanismo simple de apertura y cierre, con traba firme que mantiene la escuadra a 90° durante su uso.

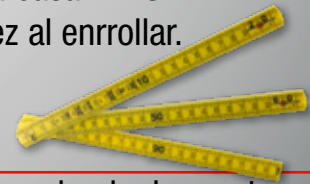

	CÓDIGO	M	U. X CAJA
<b>RETROBLOCK</b> FLEJE DE 16 MM	<b>EV502</b>	2	12
	<b>EV503</b>	3	12
	<b>EV505</b>	5	12

<b>PREMIUMBLOCK</b> FLEJE DE 25 MM	<b>EV525</b>	5	12
	<b>EV508</b>	8	12
	<b>EV510</b>	10	12

	CÓDIGO	M	U. X CAJA
<b>STANDARD</b> <b>ACERO NIQUELADO</b> FLEJE 12 MM	<b>EV105</b>	5	12
	<b>EV110</b>	10	12
	<b>EV115</b>	15	12
	<b>EV120</b>	20	12
	<b>EV125</b>	25	12

<b>AGRIMENSOR</b> PROF. ACERO FLEJE 12 MM	<b>EV130</b>	30	12
	<b>EV150</b>	50	1
	<b>EV210</b>	100	1

	CÓDIGO	M	U. X CAJA
<b>METRO</b> <b>PLÁSTICO</b> VARILLA DE 16 MM	<b>EV100</b>	1	12
	<b>EV200</b>	2	12

# MÉTRICA y MEDIDAS Nazka



## CINTA MÉTRICA

Nazka



<b>PREMIUM</b>	<b>CM200</b>	3 M	12	] uds x caja
<b>Nazka</b>	<b>CM201</b>	5 M	12	
	<b>CM202</b>	7.5 M	6	
	<b>CM203</b>	10 M	6	

<b>IMPORTADA</b>	<b>CM204</b>	3 M	12	] uds x caja
	<b>CM205</b>	5 M	12	
	<b>CM206</b>	7.5 M	12	
	<b>CM207</b>	10 M	12	

Nazka

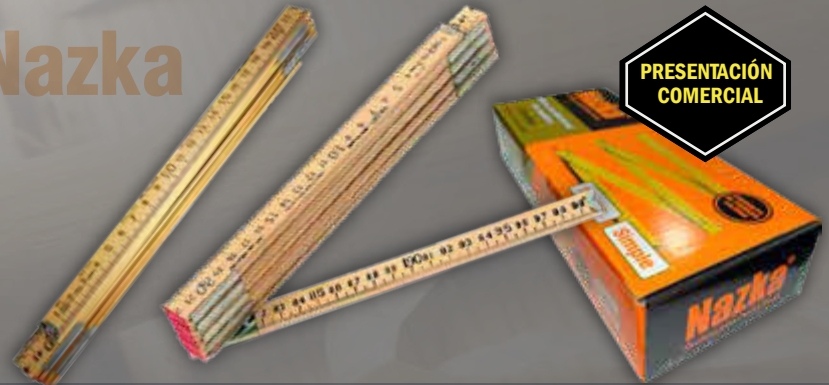

<b>AGRIMENSOR</b>	<b>CM300</b>	30 M	1	] uds x caja
	<b>CM301</b>	50 M	1	
	<b>CM302</b>	100 M	1	

<b>METRO MADERA</b>	<b>CM400</b>	SIMPLE X 1 M	12	] uds x caja
<b>Nazka</b>	<b>CM401</b>	DOBLE X 2 M	12	



<b>REGLA METÁLICA</b>	<b>CM500</b>	30 CM	10	] uds x caja
	<b>CM501</b>	50 CM	10	
	<b>CM502</b>	100 CM	10	

[www.engros.com.ar](http://www.engros.com.ar)



engrosdistribuidora



engros.distribuidora

Calle La Portada 3951, BERISSO 1923

221 5220273

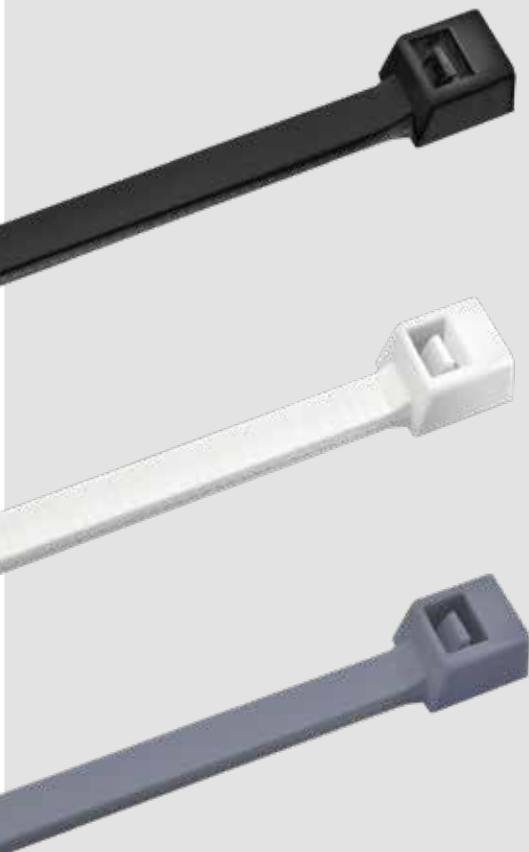

### PRECINTO DE NYLON NEGRO

CODIGO	MEDIDAS mm	UD. X BOLSA	BOLSAS X PACK
25100N	2,5x100	100	50
25140N	2,5x140	100	50
36150N	3,6x150	100	25
36200N	3,6x200	100	25
36250N	3,6x250	100	25
36300N	3,6x300	100	25
48200N	4,8x200	100	20
48250N	4,8x250	100	20
48300N	4,8x300	100	20
48350N	4,8x350	100	20
48400N	4,8x400	100	15
48450N	4,8x450	100	10
75300N	7,5x300	100	5
75350N	7,5x350	100	5
75400N	7,5x400	100	5
75450N	7,5x450	50	5
75500N	7,5x500	50	5
75550N	7,5x550	50	5
75600N	7,5x600	50	5
95400N	9,5x400	50	5
95500N	9,5x500	50	5
95600N	9,5x600	50	5
95750N	9,5x750	25	10
95850N	9,5x850	25	10
95950N	9,5x950	25	10

### PRECINTO DE NYLON BLANCO

CODIGO	MEDIDAS mm	UD. X BOLSA	BOLSAS X PACK
25100B	2,5x100	100	50
25140B	2,5x140	100	50
36150B	3,6x150	100	25
36200B	3,6x200	100	25
36250B	3,6x250	100	25
36300B	3,6x300	100	25
48200B	4,8x200	100	20
48250B	4,8x250	100	20
48300B	4,8x300	100	20
48350B	4,8x350	100	20
48400B	4,8x400	100	15
48450B	4,8x450	100	10
75300B	7,5x300	100	5
75350B	7,5x350	100	5
75400B	7,5x400	100	5
75450B	7,5x450	50	5
75500B	7,5x500	50	5
75550B	7,5x550	50	5
75600B	7,5x600	50	5

### PRECINTO DE NYLON GRIS

CODIGO	MEDIDAS mm	UD. X BOLSA	BOLSAS X PACK
48400G	4,8x400	100	15

### ABRAZADERA ACERO INOXIDABLE

#### 9 MM ( CAJAS )

CODIGO	MEDIDAS mm	CONT. CAJA	CAJAS X PACK
AG9 8-12	9 mm 8-12	100	4
AG9 10-16	9 mm 10-16	100	4
AG9 12-20	9 mm 12-20	100	4
AG9 16-25	9 mm 16-25	100	4
AG9 20-32	9 mm 20-32	50	6
AG9 25-40	9 mm 25-40	50	6
AG9 32-50	9 mm 32-50	50	4
AG9 40-60	9 mm 40-60	50	4
AG9 50-70	9 mm 50-70	50	4
AG9 60-80	9 mm 60-80	50	4
AG9 70-90	9 mm 70-90	50	3
AG9 80-100	9 mm 80-100	50	3

#### 12 MM ( CAJAS )

CODIGO	MEDIDAS mm	CONT. CAJA	CAJAS X PACK
AG12 12-20	12 mm 12-20	100	3
AG12 16-25	12 mm 16-25	100	3
AG12 20-32	12 mm 20-32	100	4
AG12 25-40	12 mm 25-40	100	4
AG12 32-50	12 mm 32-50	50	4
AG12 40-60	12 mm 40-60	50	3
AG12 50-70	12 mm 50-70	50	3
AG12 60-80	12 mm 60-80	50	3
AG12 70-90	12 mm 70-90	50	3
AG12 80100	12 mm 80-100	50	2
AG12 90110	12 mm 90-110	50	2
AG12 10012	12 mm 100-120	50	2

Abrazaderas metálicas tipo alemanas. Material: Acero inoxidable (201W2)  
Ancho de banda: 9,12 mm con sinfin ranurado.





**TARUGO NYLON C (CAJAS)**

ART.	CANT. CAJA	CAJAS X PACK
C4	200	30
C5	200	30
C6	100	100
C8	100	50
C10	50	50
C12	25	50
C14	20	15

**TARUGO NYLON BM ( BOLSAS)**

ART.	CANT. CAJA	CAJAS X PACK
BM5	1000	10
BM6	2000	5
BM8	1000	5
BM10	500	5
BM12	250	5



**TARUGO NYLON C/ ARANDELA CA (CAJAS)**

ART.	CANT. CAJA	CAJAS X PACK
CA4	200	15
CA5	200	15
CA6	100	15
CA8	100	15
CA10	50	15
CA12	25	15
CA14	20	15

**TARUGO NYLON C/ ARANDELA BMA (BOLSAS)**

ART.	CANT. CAJA	CAJAS X PACK
BMA6	2000	5
BMA8	1000	5
BMA10	500	5
BMA12	250	5



**TARUGO MULTIUSO SIN ARANDELA MN (CAJAS)**

ART.	CANT. CAJA	CAJAS x PACK
MN6	100	25
MN8	50	25
MN10	25	25



**TARUGO MULTIUSO CON ARANDELA MNA (CAJAS)**

ART.	CANT. CAJA	CAJAS X PACK
MNA6	100	25
MNA8	50	25
MNA10	25	25



**TARUGO TRES CORTES TC (CAJAS)**

ART.	CANT. CAJA	CAJAS x PACK
<b>TC6</b>	100	25
<b>TC8</b>	50	25
<b>TC10</b>	25	25
<b>TC12</b>	20	25



**TARUGO TRES CORTES TCG (BOLSAS)**

ART.	CANT. X BOLSA	BOLSAS X PACK
<b>TC6G</b>	1000	1
<b>TC8G</b>	1000	1
<b>TC10G</b>	500	1
<b>TC12G</b>	250	1



**TARUGO NYLON EXTRA LARGO CLHS (CAJAS)**

ART.	CANT. CAJA	CAJAS x PACK
<b>CLHS6</b>	15	25
<b>CLHS8</b>	15	25
<b>CLHS1</b>	15	25



**TARUGO MECHA PARA PLACA YESO**

ART.	CANT. CAJA	CAJAS x PACK
<b>CDUR</b>	25	25
<b>BMDUR</b>	1000	1



**CLAVIJAS PARA CABLE CANAL CC (CAJAS)**

ART.	CANT. CAJA	CAJAS x PACK
<b>CC6</b>	100	25



**TARUGO PASA PRECINTO PP (CAJAS)**

ART.	CANT. CAJA	CAJAS x PACK
<b>PP6</b>	100	25



**TARUGO PARA HUECO Y DURLOCK HD**

ART.	CANT. CAJA	CAJAS x PACK
<b>HD10</b>	50	25
<b>HD20</b>	50	25

**GRAMPA NYLON PARA CAÑO DE LUZ TLC (BOLSAS)**

ART.	CANT. X BOLSA	BOLSAS X PACK
<b>TLC 5/8</b>	100	5
<b>TLC 3/4</b>	100	5
<b>TLC 7/8</b>	50	5
<b>TLC 1</b>	50	5

## SEPARADORES - NIVELADORES PARA CERÁMICOS Y PORCELANATO

### SEPARADOR CRUZ

CODIGO	ANCHO DE SEPARACION	CONT. X BOLSA	BOLSAS X PACK
CR015	1,5 mm	250	50
CR020	2 mm	250	50
CR025	2,5 mm	250	40
CR030	3 mm	200	30
CR040	4 mm	200	30
CR055	5,5 mm	150	30
CR085	8,5 mm	50	50

### SEPARADOR TE

CODIGO	ANCHO DE SEPARACION	CONT. X BOLSA	BOLSAS X PACK
TE020	2 mm	250	50
TE110	11 mm	50	50
TE150	15 mm	50	30

### NIVELADOR

CODIGO	ANCHO DE SEPARACION	CONT. X BOLSA	BOLSAS X PACK
CN010	cuña dentada p/ nivelador de 0,5 a 5 mm	250	50
CD010	cuña dentada p/ nivelador de 5 a 13 mm	50	50
NS015	nivelador - separador 1,5 mm	50	30

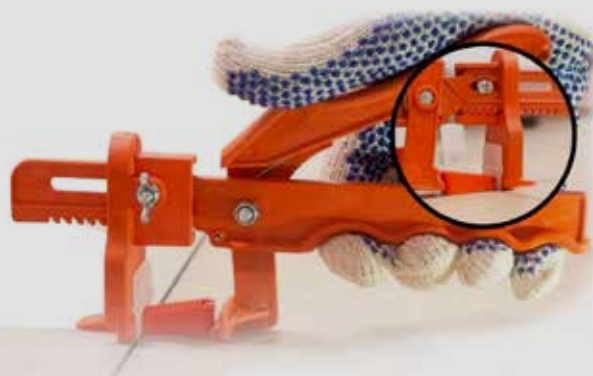
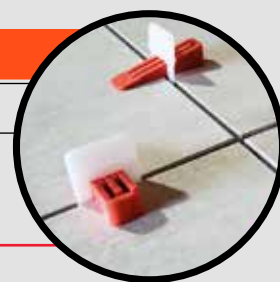

### PINZA NIVELADORA ARCO/CUÑA

CODIGO	PRESENTACIÓN
PNS01	caja x 20 unidades



# MECHAS

# NEIKE®

# ZIMBA

European Quality



**PRESENTACIÓN  
COMERCIAL**

MECHA WIDIA  
a partir de 10 mm  
x unidad



NEIKE®

MECHA WIDIA  
de 3 a 8 mm  
BLISTER x 10 Uds



**PRESENTACIÓN  
COMERCIAL**

MECHA RADIAL  
P/ CERÁMICA



## MECHA WIDIA

<b>NE0364</b>	3 MM X 64 MM
<b>NE0476</b>	4 MM X 76 MM
<b>NE0587</b>	5 MM X 87 MM
<b>NE0693</b>	6 MM X 93 MM
<b>NE08113</b>	8 MM X 113 MM
<b>NE10113</b>	10 MM X 113 MM
<b>NE12145</b>	12 MM X 145 MM
<b>NE14145</b>	14 MM X 145 MM

## MECHA WIDIA S/ MEDIA

<b>NE06250</b>	6 MM X 250 MM
<b>NE08250</b>	8 MM X 250 MM
<b>NE10250</b>	10 MM X 250 MM
<b>NE12250</b>	12 MM X 250 MM
<b>NE14250</b>	14 MM X 250 MM

## MECHA WIDIA S/ LARGA

<b>NE06400</b>	6 MM X 400 MM
<b>NE08400</b>	8 MM X 400 MM
<b>NE10400</b>	10 MM X 400MM
<b>NE12400</b>	12 MM X 400 MM
<b>NE14400</b>	14MM X 400MM

**NE0001** MECHA RADIAL P/ CERÁMICA

## MECHA PALETA P/ MADERA

<b>1030</b>	6 MM.	<b>1038</b>	22 MM.
<b>1031</b>	8 MM.	<b>1039</b>	25 MM.
<b>1032</b>	10 MM.	<b>1040</b>	28 MM.
<b>1033</b>	12 MM.	<b>1041</b>	30 MM.
<b>1034</b>	14 MM.	<b>1042</b>	32 MM.
<b>1035</b>	16 MM.	<b>1043</b>	35 MM.
<b>1036</b>	18 MM.	<b>1044</b>	38 MM.
<b>1037</b>	20 MM.		



ZIMBA  
European Quality

[www.engros.com.ar](http://www.engros.com.ar)



engrosdistribuidora



engros.distribuidora

Calle La Portada 3951, BERISSO 1923



221 5220273



NE0003



CORTADORA CERÁMICA

NE0002 GRINGA 42 CM

NE0003 MAXI 50 CM



PRESENTACIÓN  
COMERCIAL

NE0004 RUEDA REP. CORT. CERAM.

NE0004

DISPLAY X 5 UD

NE0005 PINZA CORTA CERÁMICA  
+ LÁPIZ WIDIA

NE0006 LÁPIZ TRAZADOR DE WIDIA



NE0005

NE0006



PRESENTACIÓN  
COMERCIAL

BLISTER x 10 Uds



SERRUCHO CARPINTERO  
CABO MADERA

- NE0010** 400MM
- NE0011** 450MM
- NE0012** 500MM
- NE0013** 550MM
- NE0014** 600MM



**NE0015** SERRUCHO PODA CURVO  
295 MM MANGO MADERA

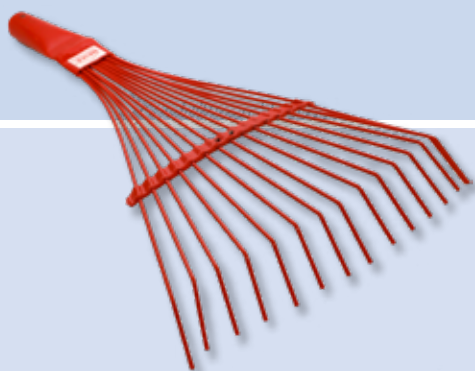

BARRE HOJA METÁLICO

- NE0009** FIJO
- NE0008** REGULABLE C/CABO
- NE0007** REGULABLE S/CABO

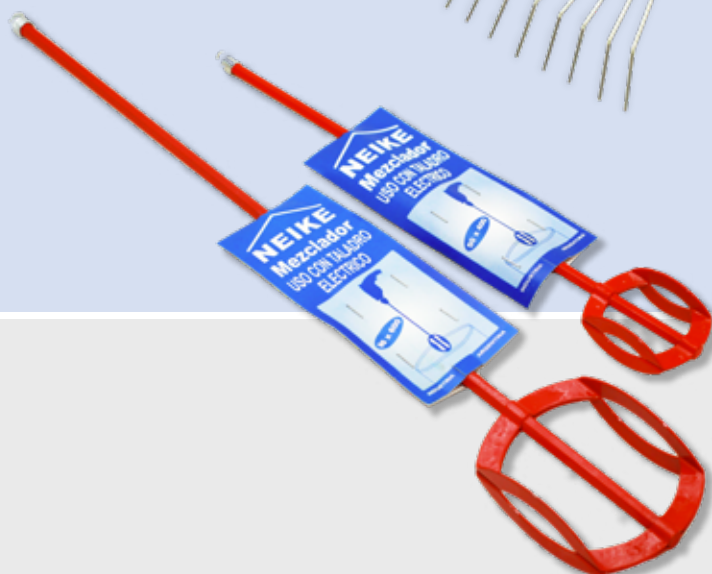
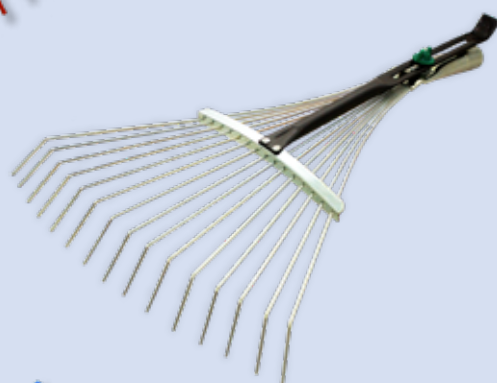

MEZCLADOR DE PINTURA  
P/ TALADRO

- NE0016** 50 X 400MM
- NE0017** 90 X 600MM

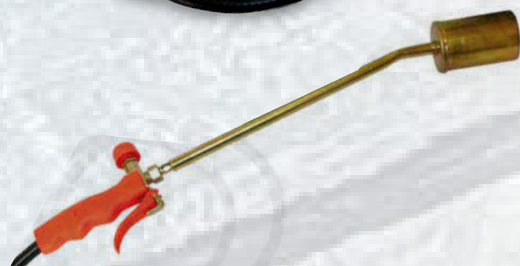

**CHISPERO REDONDO  
P/ENCENDIDO**

584

## **SOPLETE TECHISTA**

### **CORTO**

**G100** 38mm Mang. 1/2"

**G103** 38mm Mang. 3/8"

**G110** 50mm Mang. 1/2"

**G113** 50mm Mang. 3/8"

### **LARGO QUEMADOR 34 CM.**

**G130** 50mm Mang. 1/2"

**G133** 50mm Mang. 3/8"

### **LARGO QUEMADOR 70 CM.**

**G170** 50mm Mang. 1/2"

## **SOLDADOR CURVO**

**G200** Mang. 1/2"

**G203** Mang. 3/8"

*Todos los sopletes y soldadores están provistos con manguera de 1,5mm aprobada*



**CHISP-PIEDRA  
REPUESTO P/CHISPERO**

585

**PRESENTACIÓN  
COMERCIAL**



**Terraaja PVC 3 en 1  
TE01 1/2", 3/4", 1"**



**Terraaja Individual**

- TE02 1/2"**
- TE03 3/4"**
- TE04 1"**

**Regulador de  
gas p/ garrafa  
de 10 Kg.  
APROBADO**



- REGCAB** Cabezal
- REG080** Reg. c/ manguera de 0.80 m
- REG150** Reg. c/ manguera de 1.50 m
- REG200** Reg. c/ manguera de 2.00 m



## Flexible Mallado Agua Conexión bronce Niquelado 1/2"

<b>DX620</b>	20cm.	<b>DX640</b>	40cm.
<b>DX630</b>	30cm.	<b>DX650</b>	50cm.
<b>DX635</b>	35cm.	<b>DX660</b>	60cm.



## Flexible Mallado Agua Conexiones Bronce 3/4"

<b>DX920</b>	20cm.
<b>DX930</b>	30cm.
<b>DX940</b>	40cm.
<b>DX950</b>	50cm.

## Flexible Mallado Gas Conexiones Metálicas 1/2"

<b>DX730</b>	30cm.	<b>DX780</b>	80cm.
<b>DX740</b>	40cm.	<b>DX800</b>	100cm.
<b>DX750</b>	50cm.	<b>DX820</b>	120cm.
<b>DX760</b>	60cm.		



### SELLADOR SILICONA NEUTRO

Pintable, de excelente flexibilidad, elasticidad y resistencia a los agentes climáticos, impermeable y antihongos. No ataca a los metales ni al policarbonato, ideal para cementos, hormigón, fibrocemento y sellado entre vidrios, plásticos, carpintería metálica, etc.



- SR100** 280 CC TRANSPARENTE 25
- SR101** 140 CC TRANSPARENTE 28
- SR102** 280 CC BLANCO 25
- SR103** 280 CC NEGRO 25

280 CC CAJA X 25 Uds.  
140 CC CAJA X 28 Uds.

Uds. X buito

### SELLADOR JUNTAS Y GRIETAS

Sellador Pintable de un solo componente acrílico, de alta resistencia al sol y la lluvia con mínima contracción al curar. Ideal para rajaduras, uniones, juntas en paredes, pisos, cerramiento de aluminio o madera con mampostería, pegado de molduras en cielorrasos, bañaderas e hidros, azulejos, cerámica y perfilería en general (elimina el uso de tornillos).



- SR200** BLANCO X 304 ML
- SR201** BLANCO X 1.3 KG
- SR202** BLANCO X 5.0 KG

### SELLADOR ADHESIVO REGITAK

Gran poder de sellado y adhesión. Apto para interior y exterior, no desliza, impermeable luego de su curado total. Ideal para cerámica, madera, metal, azulejos, vidrio, policarbonato, corcho, pvc, yeso, alfombras, ópticas de automotores, telas, venecitas, etc.



**SR700** 150CC

### SELLADOR MOLDURAS Y ZÓCALOS

Especialmente diseñado para el pegado y sellado de molduras, zócalos, construcción en seco, placas anti humedad de todo tipo (telgopor, madera, poliuretano, yeso, durlock) adhiere sobre superficies húmedas.



**SR107** BLANCO X 304 ML  
CAJA X 25 Uds.

### SELLADOR PARA MADERA

Especialmente diseñado para el sellado de juntas entre maderas, madera con manpostería, WPC, muebles, pisos, sellado de cabañas, zocalos, decks, etc. Adhiere en todo tipo de materiales, de uso interior y exterior por su gran resistencia y elasticidad. Tiene un rendimiento de 16 m. lineales en un cordón de 4 x 4 mm.



- SR400** 280 CC NOGAL
- SR401** 280 CC PINO



### SELLADOR ALTA TEMPERATURA

- SR500** 300 CC NEGRO
- SR501** POMO 150 CC NEGRO
- SR502** SACHET 250 G. NEGRO



CAJA X 25 UDS.



300 CC CAJA X 25 UDS.

POMO de 150cc  
Exhibidora de 6 uds.  
(VENTA MÍNIMA 6 UDS)

Ignífugo, pintable, ecológico. De un solo componente basado en el uso de resinas vehículos sintéticos y modificadores que aseguran características de resistencia mecánica, estanqueidad y resistencia a altas temperaturas (1000° C). Ideal para caños de escape, salamandras, estufas, hornos de todo tipo, tuberías de calefacción y calderas.



### SELLADOR MULTIUSO

- SR600** 300 CC GRIS
- SR601** 300 CC NEGRO

CAJA X 25 UDS.

Su alto contenido de elastómeros lo hace un sellador con un excelente grado de elasticidad, con un tiempo medio y/o rápido de secado. PINTABLE. Ideal para todo tipo de sanitarios, bañaderas, mesadas, piletas, juntas de dilatación de todo tipo, canaletas, vabetas. Excelente tapa goteras.



### MASILLA TARUGO PARA INODOROS

- SR900**  
GRIS X 1KG  
CAJA X 12 UDS.

Sellador solido tipo Mastic, fácilmente maleable. Es una masilla que no envejece, manteniéndose elástica sin resquebrajarse con alta resistencia a los líquidos cloacales, evitando la difusión de olores. Ideal para el sellado del embudo del inodoro con el caño cloacal.



CAJA X 25 UDS.

### SELLADOR TAPA GOTERAS

- SR800**  
SACHET 500 G. NEGRO

Sellador a base de Asfalto y caucho, diseñado para el sellado de goteras en techos de chapa, fibrocemento, mampostería y hasta en membrana con o sin aluminio.



**fanacola 90**  
**ADHESIVO DE CONTACTO**

<b>FC131</b>	40 gs	40	UDS X BULTO
<b>FC132</b>	100 gs	40	
<b>FC133</b>	200 gs	24	
<b>FC134</b>	400 gs	12	
<b>FC135</b>	750 gs	12	
<b>FC136</b>	2,8 kg	4	
<b>FC242</b>	14 Kg (LATA)	1	

**FANACOLA 90** ES UN ADHESIVO DE DOBLE CONTACTO PARA USO PROFESIONAL Y HOGAREÑO. ES UTILIZADO PARA EL ARMADO DE MUEBLES, TAPICERÍA Y DECORACIÓN. ES APTO PARA PEGADO DE ALFOMBRAS Y PISOS VINÍLICOS. PEGAS MÚLTIPLES MATERIALES ENTRE SÍ COMO; GOMA, TELA, MADERA, CUERO, METALES, LAMINADOS, VIDRIO, ETC.



**fanacola 1011**  
**ADHESIVO VINÍLICO PARA MADERA**

<b>FC946</b>	125 gs (POMO)	48	UDS X BULTO
<b>FC926</b>	250 gs (POMO)	30	
<b>FC950</b>	1/4 Kg	24	
<b>FC951</b>	1/2 Kg	12	
<b>FC952</b>	1 kg	12	
<b>FC957</b>	4 kg	4	
<b>FC958</b>	20 kg (BALDE)	1	

**FANACOLA 1011** ES UN ADHESIVO VINÍLICO, SIN SOLVENTES, DE USO GENERAL, PEGA TODO TIPO DE MADERAS, ENTARUGADOS Y ENCHAPADOS. ESPECIALMENTE DISEÑADO PARA LA INDUSTRIA DE LA CARPINTERÍA, ES TAMBIÉN USADO PARA EL PEGADO DE ARTESANÍAS, PAPEL, CORCHO Y CARTÓN.



## fanatite 520

### ADHESIVO DE POLIURETANO

<b>FC259</b>	50 gs (POMO)	40	UDS X BULTO
<b>FC293</b>	330 gs (POMO)	24	
<b>FC258</b>	1Kg. (POMO)	5	

FANATITE ES UN ADHESIVO MONOCOMPONENTE DE POLIURETANO, PEGA GRAN VARIEDAD DE SUPERFICIES. ES APTO PARA MUEBLES DE USO EXTERIOR, COCINA Y BAÑO. POSEE EXCELENTE RESISTENCIA A LA HUMEDAD Y UN PEGADO EFECTIVO ENTRE LOS MATERIALES MOJADOS O HÚMEDOS.

PEGA, SELLA Y RELLENA. BAJO ESPUMADO. RÁPIDO CURADO. NO CONTRAE. SIN SOLVENTES 100% RESISTENTE A LA INTEMPERIE. PEGADO EFECTIVO ENTRE MATERIALES AUNQUE ESTEN HÚMEDOS O MOJADOS POR SU EXCELENTE RESISTENCIA AL AGUA

**NUEVO**

## fanasil

### SILICONA A PINCEL TRANSPARENTE



<b>FC903</b>	350 G.	12	UDS X BULTO
<b>FC904</b>	750 G.	12	
<b>FC905</b>	3 KG.	4	
<b>FC906</b>	14 KG.	1	

SELLADOR DE FÁCIL APLICACIÓN, SECADO RÁPIDO Y EXCELENTE RESISTENCIA A LA HUMEDAD. RECOMENDADO PARA USO INTERIOR Y EXTERIOR. POSEE GRAN RESISTENCIA AL ENVEJECIMIENTO CLIMÁTICO, A TEMPERATURAS ALTAS Y BAJAS, AL OZONO Y A LOS RAYOS UV. IDEAL PARA SELLAR GRIETAS, FISURAS, FILTRACIONES E IMPERMEABILIZAR DIFERENTES SUPERFICIES.

# LUBRICANTES y GRASAS



PRODUCTOS  
**TF3**



## AEROSOLES



### LUBRICANTE MULTIUSO TF3

COD. | VERSIÓN | PAQUETE

**LG100** | 250 cc | 12 u.  
**LG101** | 440 cc | 12 u.



### LUBRICANTE PTFE

COD. | VERSIÓN | PAQ.

**LG102** | 250 cc | 12 u.



### LUB. DESOX. GRAFITADO

COD. | VERSIÓN | PAQ.

**LG103** | 250 cc | 12 u.



### GRAFITO SECO

COD. | VERSIÓN | PAQUETE

**LG104** | 237 cc | 12 u.



### LUBRICANTE CADENA

COD. | VERSIÓN | PAQ.

**LG105** | 250 cc | 12 u.



### LUBRICANTE ARMAS

COD. | VERSIÓN | PAQ.

**LG106** | 235 cc | 16 u.



### LIMPIA CONTACTO ISOPROPIL

COD. | VERSIÓN | PAQUETE

**LG107** | 430 cc | 12 u.



### LIMPIA CONTACTO

COD. | VERSIÓN | PAQ.

**LG108** | 250 cc | 12 u.



### DESLIZANTE PARA CAÑOS TF3

COD. | VERSIÓN | PAQ.

**LG109** | 440 cc | 12 u.



# LUBRICANTES y GRASAS



PRODUCTOS  
**TF3**



## AEROSOLES



### ANTIDESLIZANTE DE CORREAS

COD. | VERSIÓN | PAQUETE

**LG110** | 250 cc | 12 u.  
**LG111** | 440 cc | 12 u.



### ARRANCA MOTORES

COD. | VERSIÓN | PAQ.

**LG112** | 260 G. | 12 u.



### INFLA Y REPARA NEUMÁTICOS

COD. | VERSIÓN | PAQ.

**LG113** | 300 G. | 12 u.



### GRASA GRAFITADA

COD. | VERSIÓN | PAQ.

**LG114** | 250 cc | 12 u.



### GRASA LITIO

COD. | VERSIÓN | PAQ.

**LG115** | 250 cc | 12 u.



### SILICONA AUTO

COD. | VERSIÓN | PAQ.

<b>FRESIA</b>	<b>LG116</b>	400 cc	12 u.
<b>LAVANDA</b>	<b>LG117</b>	400 cc	12 u.
<b>LIMÓN</b>	<b>LG118</b>	400 cc	12 u.
<b>VAINILLA</b>	<b>LG119</b>	400 cc	12 u.

## ACEITERA



### MULTIUSO

COD. **LG200**

VERSIÓN 100 ml.  
PAQ. 24 u.



### MÁQUINA COSER

COD. **LG201**

VERSIÓN 100 ml.  
PAQ. 24 u.



### PARA BICICLETAS

COD. **LG202**

VERSIÓN 100 ml.  
PAQ. 24 u.



### PARA ARMAS

COD. **LG203**

VERSIÓN 100 ml.  
PAQ. 24 u.

www.engros.com.ar



engrosdistribuidora



engros.distribuidora

Calle La Portada 3951, BERISSO 1923

221 5220273

# LUBRICANTES y GRASAS



PRODUCTOS  
**TF3**



## GRASA

### LITIO



COD. | VERSIÓN | PAQUETE

<b>LG300</b>	100 G.	12 u.
<b>LG301</b>	250 G.	12 u.
<b>LG302</b>	500 G.	12 u.
<b>LG303</b>	900 G.	6 u.
<b>LG304</b>	4 KG.	1 u.
<b>LG305</b>	18 KG.	1 u.

### AMARILLA VASELINADA



COD. | VERSIÓN | PAQUETE

<b>LG306</b>	100 G.	12 u.
<b>LG307</b>	250 G.	12 u.
<b>LG308</b>	450 G.	12 u.
<b>LG309</b>	900 G.	6 u.

### GRAFITADA



COD. | VERSIÓN | PAQUETE

<b>LG310</b>	100 G.	12 u.
<b>LG311</b>	250 G.	12 u.
<b>LG312</b>	450 G.	12 u.
<b>LG313</b>	900 G.	6 u.
<b>LG314</b>	4 KG.	1 u.

### RODAMIENTO



COD. | VERSIÓN | PAQ.

<b>LG315</b>	100 G.	12 u.
<b>LG316</b>	250 G.	12 u.
<b>LG317</b>	500 G.	12 u.
<b>LG318</b>	900 G.	6 u.
<b>LG319</b>	4 KG.	1 u.

### ESPUMA POLIURETÁNICA



COD. | VERSIÓN | PAQ.

<b>LG400</b>	300 cc	12 u.
<b>LG401</b>	500 cc	12 u.

### SELLADOR ROSCAS



COD. | VERSIÓN | PAQUETE

<b>LG402</b>	25 cc	72u.
--------------	-------	------

### CREMA ADHESIVA EPOXI



COD. | VERSIÓN | PAQ.

<b>LG403</b>	ACERO	12 u.
<b>LG404</b>	BLANCA	12 u.

### ADHESIVO PVC



COD. | VERSIÓN | PAQ.

<b>LG405</b>	60 CM	12 u.
<b>LG406</b>	110 CM	12 u.
<b>LG407</b>	250 CM	6 u.



# LUBRICANTES y GRASAS



PRODUCTOS  
**TF3**



## GRAFITO EN POLVO

COD. | VER. | PAQ.  
**LG408** 60 G. 12 u.



## ACEITE SOLUBLE

COD. | VER. | PAQ.  
**LG409** 6 u.  
**LG410** 1 u.



## DESTAPA CAÑERÍAS

COD. | VERSIÓN | PAQUETE  
**LG500** 500 ml. 12 u.  
**LG501** 1 L 6 u.



## DESTAPA CAÑERÍAS GEL

COD. | VERSIÓN | PAQUETE  
**LG505** | 1 L 6 u.



## QUITA SARRO Y ÓXIDO

COD. | VERSIÓN | PAQUETE  
**LG502** 500 ml. 12 u.  
**LG503** 1 L 6 u.



## DESOXIDANTE FOSFATIZANTE

COD. | VERSIÓN | PAQUETE  
**LG504** | 1 L 6 u.



## LIMPIADOR UNIVERSAL

COD. | VERSIÓN | PAQUETE  
**LG510** 500 ml. 12 u.  
**LG511** 1 L 6 u.

## LIMPIA MANO BASE AGUA ABRASIVO PERFUMADO NARANJA



COD. | VERSIÓN | PAQUETE  
**LG600** POTE 500 G. 12 u.  
**LG601** POTE 1 kg. 6 u.  
**LG602** BALDE 4 Kg. 1 u.

www.engros.com.ar



engrosdistribuidora



engros.distribuidora

Calle La Portada 3951, BERISSO 1923

221 5220273

**SMARTFIX**  
MEMBRANA AUTOADHESIVA

MEMBRANAS

GRUPO  
**AMAFREN**

**Aislotech**  
100% ALUMINIO PURO  
DURA LO QUE SU TECHO DURA



### SMART FIX N 950

Esta línea de membranas son usadas para impermeabilización de bandas, como pueden ser en aberturas en construcción seca sellando el papel respirable con los perfiles, en rajaduras de paredes o losas de cemento, en encuentros de membranas asfálticas y paredes, en uniones de chapas, encuentros de chapas o tejas con paredes, agujeros en chapas, corrosión en canaletas de techos, sellado de unión de bajadas de caños de desagüe, pérdidas en tanques de agua, etc.

Su aplicación es recomendada entre 10°C y 35°C, y su temperatura de trabajo es -30°C a 55°C.

Estan provistas de adhesivo asfáltico **POTENCIA ADHESIVE** que garantiza un excelente tac y pegado instantáneo, y muy buenos valores de adherencia e impermeabilización, con un espesor de 0.95 mm



Código	Descripción	UnxBulto
<b>EN1010</b>	10 CM X 10 M	18
<b>EN1510</b>	15 CM X 10 M	12
<b>EN2510</b>	25 CM X 10 M	6

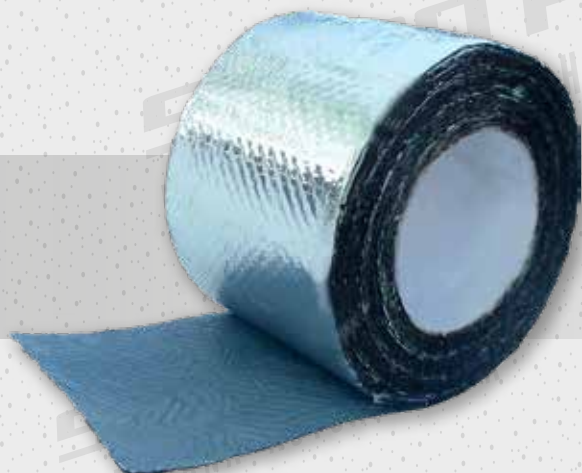

[www.engros.com.ar](http://www.engros.com.ar)



engrosdistribuidora



engros.distribuidora

Calle La Portada 3951, BERISSO 1923

221 5220273

# ENGROS

INDUSTRIA  ARGENTINA

## BARRALES DE MADERA CEDRO



### KIT BARRAL COMPLETO 22 MM

<b>KIT140</b>	X 1.40
<b>KIT160</b>	X 1.60
<b>KIT180</b>	X 1.80
<b>KIT200</b>	X 2.00
<b>KIT220</b>	X 2.20
<b>KIT240</b>	X 2.40

10 unidades  
x bulto



### PRESENTACIÓN COMERCIAL



### BARRAL LISO

<b>BL140</b>	X 1.40
<b>BL160</b>	X 1.60
<b>BL180</b>	X 1.80
<b>BL200</b>	X 2.00
<b>BL220</b>	X 2.20
<b>BL240</b>	X 2.40

10 unidades  
x bulto



### SOPORTE MADERA

**SA022** ABIERTO 22 MM  
**SC022** CERRADO 22 MM

50 uds. x bulto



### TERMINAL MADERA

**TB022** 22 MM 50 uds. x bulto



### ARGOLLA MADERA

**AL022** 22 MM 50 uds. x bulto

[www.engros.com.ar](http://www.engros.com.ar)



engrosdistribuidora



engros.distribuidora

Calle La Portada 3951, BERISSO 1923



221 5220273



**MULTIFILAMENTO  
POLIPROPILENO**

Cod.	Medidas	Rollo
<b>SM0003</b>	3MM	200 M
<b>SM0004</b>	4MM	200 M
<b>SM0005</b>	5MM	100 M
<b>SM0006</b>	6MM	100 M
<b>SM0007</b>	7MM	100 M
<b>SM0008</b>	8MM	100 M
<b>SM0010</b>	10MM	100 M
<b>SM0012</b>	12MM	100 M
<b>SM0014</b>	14MM	100 M
<b>SM0016</b>	16MM	100 M
<b>SM0018</b>	18MM	100 M
<b>SM0020</b>	20MM	100 M



**MULTIFILAMENTO  
POLIPROPILENO COLOR**

Cod.	Medidas	Rollo
<b>SC0006</b>	6 MM	100 M
<b>SC0008</b>	8 MM	100 M



**ELÁSTICA COLOR**

Cod.	Medidas	Rollo
<b>SE0006</b>	6 MM	100 M
<b>SE0008</b>	8 MM	100 M



**ARRANQUE P/ MOTORES  
POLIESTER**

Cod.	Medidas	Rollo
<b>SA0003</b>	3 MM	100 M
<b>SA0004</b>	4 MM	100 M



**HILO PP  
VIRGEN**

Cod.	Peso	Pack
<b>HP0100</b>	100 G.	10 BOBINAS



**CINTA PERSIANA REFORZADA  
ALGODÓN**

Cod.	Características	Rollo
<b>CP0003</b>	LISA N° 3	100 M
<b>CP0005</b>	RAYADA N° 5	100 M
<b>CP0010</b>	VERDE N° 10	100 M

### CABLE ACERO GALVANIZADO TEXTIL

- CA0015 (1x19) 1.50 MM X 100 MT
- CA0020 (1x19) 2.00 MM X 100 MT
- CA0025 (1x19) 2.50 MM X 100 MT
- CA0030 (6X7+1) 3.00 MM X 100 MT
- CA0040 (6X7+1) 4.00 MM X 100 MT
- CA0050 (6X7+1) 5.00 MM X 100 M

### CABLE ACERO GALVANIZADO (6X19+1) TEXTIL

- CA0060 6.00 MM X 100 MT
- CA0080 8.00 MM X 100 MT
- CA0100 10 MM X 50 MT.
- CA0127 12.7 MM X 30 MT



### MALACATE 2 TONELADAS

MA2000 Cable Acero de 5 mm x 1.95 cm de largo máximo



### EVITA SOLDADURA

- EVITA01 8X9 DIAM. 2.70 MM
- EVITA02 8X14 DIAM. 4 MM
- EVITA03 11X18 DIAM. 6 MM



### GRAMPA PRENSACABLE GALVANIZADO

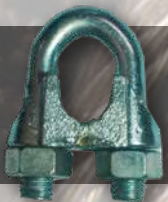

- |            |            |            |       |
|------------|------------|------------|-------|
| PCG01 1/8  | PCG04 5/16 | PCG07 1/2  | PCG10 |
| PCG02 3/16 | PCG05 3/8  | PCG08 9/16 | PCG11 |
| PCG03 1/4  | PCG06 7/16 | PCG09 5/8  | PCG12 |

### GUARDACABO P/CABLE DE ACERO



- |            |            |            |           |
|------------|------------|------------|-----------|
| GCA01 3/16 | GCA04 3/8  | GCA07 9/16 | GCA10 7/8 |
| GCA02 1/4  | GCA05 7/16 | GCA08 5/8  | GCA11 1   |
| GCA03 5/16 | GCA06 1/2  | GCA09 3/4  |           |

### GRILLETE RECTO P/ CABLE DE ACERO



- |            |            |           |
|------------|------------|-----------|
| GRA01 1/4  | GRA04 7/16 | GRA07 3/4 |
| GRA02 5/16 | GRA05 1/2  | GRA08 7/8 |
| GRA03 3/8  | GRA06 5/8  | GRA09 1   |

### SENSOR DE FUND. CROMADO



- |            |            |            |           |           |
|------------|------------|------------|-----------|-----------|
| TFC01 3/16 | TFC03 5/16 | TFC05 1/2  | TFC07 5/8 | TFC09 7/8 |
| TFC02 1/4  | TFC04 3/8  | TFC06 9/16 | TFC08 3/4 | TFC10 1   |

### CADENA PATENTE GALVANIZADA

CPG030	N° 30 (16X12MM) X 12.5 KG	5 MTS. APROX/KG
CPG035	N° 35 (18X14MM) X 12.5 KG	3,8 MTS. APROX/KG
CPG040	N° 40 (19X16MM) X 12.5 KG	2,90 MTS. APROX/KG
CPG045	N° 45 (20X18MM) X 12.5 KG	2,60 MTS. APROX/KG
CPG050	N° 50 (21X20MM) X 12.5 KG	2,00 MTS. APROX/KG
CPG060	N° 60 (24X24MM) X 12.5 KG	1,50 MTS. APROX/KG
CPG070	N° 70 (28X28MM) X 25 KG	1,00 MTS. APROX/KG
CPG080	N° 80 (32X32MM) X 25 KG	0,88 MTS. APROX/KG
CPG100	N° 100 (85X38MM) X 25 KG	0,50 MTS. APROX/KG
CPG120	N° 120 (100X88MM) X 25 KG	0,34 MTS. APROX/KG

### CADENA NUDO GALVANIZADA

CNG015	N° 15
CNG017	N° 17
CNG018	N° 18

### APAREJO A CADENA

AC1000	1TON X 2.5MTS
AC2000	2TON X 3 MTS
AC3000	3TON X 3.0MTS

### GANCHO 320 VULCAN FIJO C/SEG

GVF050	0.50 TON	GVF150	1.50 TON
GVF075	0.75 TON	GVF200	2.00 TON
GVF100	1.00 TON	GVF300	3.00 TON

### MOSQUETÓN DESTORCEDOR NIQUELADO

MDN070 70 MM

### GANCHO 322 VULCAN GIR. C/SEG

GVG075	0.75TON	GVG200	2.00TON
GVG100	1.00TON	GVG300	3.00 TON
GVG150	1.50 TON		

### MOSQUETÓN A BOTÓN

MBN01	N° 1 80 MM
MBN02	N° 2 95 MM
MBN03	N° 3 110 MM

### MOSQUETÓN C/SEG. PRESIÓN

MSP04	4 MM	MSP08	8 MM
MSP05	5 MM	MSP10	10 MM
MSP06	6 MM	MSP12	12 MM
MSP07	7 MM		

### MOSQUETÓN C/SEG. ROSCA

MSR04	4 MM	MSR07	7 MM
MSR05	5 MM	MSR08	8 MM
MSR06	6 MM		

### MOSQUETÓN ALPINO T/LLAVERO X DOC.

MAL06	6 MM
MAL08	8 MM

### ESLABÓN ABIERTO UNIÓN CADENA

EA030	3.0 MM	EA070	7.0 MM
EA040	4.0 MM	EA080	8.0 MM
EA050	5.0 MM	EA0100	10.0 MM
EA060	6.0 MM	EA0120	12.0 MM



### TORNIQUETE ZINCADO NACIONAL



TMZ01 MINI  
 T7Z01 N° 7  
 TMV01 MINI VERDE  
 CAJA X 25 UDS.



### GANCHO J. ZINC. COMP. 5/16

GJ8175	X 7 (8X175)	BOLSA X 50 UD.
GJ8200	X 8 (8X200)	
GJ8250	X 10 (8X250)	



### PLANCHUELA ZINC

PZ150	3/4 X 3/16 X 1.50 M
PZ200	3/16 X 1 X 2.00 M

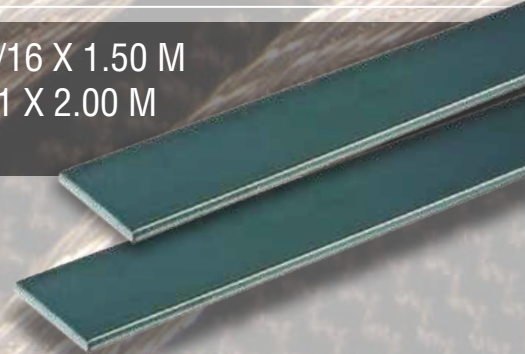

### CABLE ACERO TENDER ENVAINADO

CAT040  
 4 MM X 100 MT



### VARILLA CHATA FORRADA PVC

VACHA  
 X 25 MTS



# CINTAS PASACABLE



## CINTA PASACABLE PLÁSTICA

**CPP07** X 7 MT    **Resistencia:** Material 42 Kg/f  
**CPP10** X 10 MT    E/Terminales 37 Kg/f  
**CPP15** X 15 MT  
**CPP20** X 20 MT



## CINTA PASACABLE C/ALMA ACERO

**CPA07** X 7 MT    Autoenrollable y posee en su  
**CPA10** X 10 MT    interior un alma de acero.  
**CPA15** X 15 MT    **Resistencia:** Material 120 Kg/f  
**CPA20** X 20 MT    E/terminales 90 Kg/f



## CINTA PASACABLE PROF. NYLON

**CPN10** X 10 MT    Diseñada en copolímero de  
**CPN15** X 15 MT    Nylon con traccionador múltiple  
**CPN20** X 20 MT    de cables, trabajos extremos.  
**CPN30** X 30 MT    **Resistencia:** Material 250 Kg/f  
E/terminales 150 Kg/f

Traccionador múltiple

Modo de uso



LIDER EN CORTE

# SIN PAR®



FABRICADOS SEGUN NORMA EN 12413

## DISCO O/A C.RECTO ACERO INOXIDABLE

		BLISTER X
<b>SP11512</b>	115 X 1.2	10
<b>SP11516</b>	115 X 1.6	10
<b>SP11560</b>	115 X 6.0 DESBASTE	5
<b>SP18018</b>	180 X 1.8	10
<b>SP23018</b>	230 X 1.8	5
<b>SP35032</b>	350 X 3.2	5

## HOJA CALADORAS ACERO BIMETAL



BLISTER X 5 UNIDADES

## HOJA S. A. RÁPIDO X UD (X 10 UDS)



<b>SPAR18</b>	18 DIENTES
<b>SPAR24</b>	24 DIENTES
<b>SPAR32</b>	32 DIENTES

## HOJA S. BIMETÁLICA X UD (X 10 UDS)



<b>SPAB18</b>	18 DIENTES
<b>SPAB24</b>	24 DIENTES
<b>SPAB32</b>	32 DIENTES

## HOJA S. JUNIOR X UD (X 10 UDS)



<b>SPAJ32</b>	32 DIENTES
---------------	------------

Código	Largo útil de corte [mm]	Dientes (cada 25,4 mm)	Tipo de Corte
--------	--------------------------	------------------------	---------------

### MULTIUSO (MADERA Y PLÁSTICO)

<b>CA214</b>	50,0	14	Curvo
<b>CA218</b>	50,0	18	Curvo
<b>CA41014</b>	100,0	10/14	Recto

### METAL

<b>CA224</b>	50,0	24	Curvo
<b>CA232</b>	50,0	32	Curvo

Hojas de Sierra para máquinas caladoras fabricadas en Acero Bimetal: Este material permite obtener la combinación ideal de flexibilidad en el cuerpo de la hoja, con una alta resistencia al desgaste en la zona de los dientes. Con su revolucionario encastre unificado se adapta a todas las máquinas caladoras del mercado.

[www.engros.com.ar](http://www.engros.com.ar)



engrosdistribuidora



engros.distribuidora

Calle La Portada 3951, BERISSO 1923



221 5220273



# Discos DIAMANTADOS



Ultrafin®



Magicut® (el turbolaser)



## Ultrafin®

### 70% DIAMANTE

La mejor opción del mercado en rendimiento por costo. Disco diamantado ultrafino especial, excelente calidad y corte. Ideal para cortar porcelanato, vidrios, mosaicos, cerámica etc. corte en seco y mojado. Proporciona un corte rápido preciso y suave.

- |                          |                          |
|--------------------------|--------------------------|
| <b>DI300</b> 4 1/2 LISO  | <b>DI303</b> 7 1/4 TURBO |
| <b>DI301</b> 4 1/2 TURBO | <b>DI304</b> 9" LISO     |
| <b>DI302</b> 7 1/4 LISO  | <b>DI305</b> 9" TURBO    |



## Magicut® (el turbolaser®)

### 35% DIAMANTE

Mayor cantidad y mejor calidad de los cortes, más rápidos y prolijos tanto para el profesional como el Hobbista. Único y novedoso disco Turbolaser® que potencia el rendimiento de los dos cortes, con cambios sustanciales en la estructura, lo que convierte a este disco en un bisturí.

- |                 |
|-----------------|
| <b>DI400</b> 4" |
| <b>DI401</b> 7" |
| <b>DI402</b> 9" |





# Discos DIAMANTADOS



DIAMARK®



PROFESIONAL



Hobbista de uso intenso para profesional y usuarios corrientes que deben premiar el costo del insumo.

## DIAMARK®

### ECONÓMICO AMARILLO 21% DIAMANTE

- DI 100 4½ LASER
- DI 101 4½ LISO
- DI 102 4½ TURBO
- DI 103 7" LASER
- DI 104 7" LISO
- DI 105 7" TURBO
- DI 106 9" LASER
- DI 107 9" LISO
- DI 108 9" TURBO



DIAMARK®



PROFESIONAL

Fabricados con diamante sintético industrial de gran tamaño, de formato normalizado y soldado por fusión láser, lo que asegura excelente calidad de corte de principio a fin y seguridad al usarlo. Todos los productos cuentan con la garantía de fabricación bajo normas **ISO 94 standar 6 B I T 129002 e ISO 9002**



Profesional para usos intensos de colocadores ceramistas, constructores y todo usuario que busque el equilibrio entre costo y rendimiento.

## PROFESIONAL

### PROFESIONAL ROJO 33% DIAMANTE

- DI200 4½ LASER
- DI201 4½ LISO
- DI202 4½ TURBO
- DI203 7" LASER
- DI204 7" LISO
- DI205 7" TURBO
- DI206 9" LASER
- DI207 9" LISO
- DI208 9" TURBO

	LISO	LASER	TURBO
Asfalto		▲	
Azulejos	▲		
Baldosas y baldosones		▲	
Cerámica esmaltada	▲		□
Cerámica mono y doble cocción	▲		□
Contrapiso		▲	
Cristales y vidrios	▲		
Fibra de vidrio		▲	□
Granito		□	▲
Hormigón armado curado		▲	
Hormigón armado fresco		▲	
Ladrillos refractarios		▲	
Jadrillos		▲	□
Lajas		▲	
Mampostería		▲	
Mármoles	□		▲
Mosaicos		▲	
Piedras naturales abrasivas		▲	
Piedras naturales duras			▲
Porcelana y porcelanato	▲		□
Tejas crudas		▲	□
Tejas esmaltadas	▲		□
Vigas y viguetas		▲	

Banda Liso / Continuo : Uso Obligatorio con refrigeración (Agua)  
Banda láser / Segmentado : Refrigeración por Aire (\*)  
Banda Turbo / Combinado : Refrigeración por Aire (\*)

- ▲ Optimo
- Bueno

www.engros.com.ar



engrosdistribuidora



engros.distribuidora

Calle La Portada 3951, BERISSO 1923

221 5220273

# KLEBER

## DISCOS DE CORTE



### DISCOS MULTI MATERIAL PARA MADERA:

- ◆ Aptos para madera con clavo, plásticos, yeso, y mampostería.
- ◆ Corte constante rápido y suave
- ◆ No se rompen ni se traban, otorgando más seguridad al usuario.

**KB70115** 115 MM

**KB70180** 180 MM

### DISCO DIAMANTADO PARA METAL:

- ◆ Rinde 50 veces más que un disco de corte tradicional
- ◆ Tecnología Alemana de máxima calidad
- ◆ Mayor rapidez y seguridad en sus cortes

**KB65115** 115 MM

**KB65180** 180 MM



PRESENTACIÓN  
COMERCIAL

CAJA EXHIBIDORA  
X 5 UNIDADES



[www.engros.com.ar](http://www.engros.com.ar)



engrosdistribuidora



engros.distribuidora

Calle La Portada 3951, BERISSO 1923



221 5220273



Canadian®  
HERRAMIENTAS

SIERRAS  
CIRCULARES



## LINEA CELESTE USOS GENERALES



COD.	MEDIDAS	DIENTES	BUJE CENTRAL Y ADAPTADOR	RPM max.
1180	4 1/2"	20	22mm - 5/8"	13500
1181	4 1/2"	24	22mm - 5/8"	8500
1182	4 1/2"	30	30mm - 1"	5500
1183	4 1/2"	36	30mm - 1"	6500
1184	7 1/4"	24	30mm - 1"	3800
1185	7 1/4"	30	30mm - 1"	3800
1186	7 1/4"	36	30mm - 1"	3800
1187	7 1/4"	48	30mm - 1"	3800
1191	9"	30	30mm - 1"	3800
1192	9"	36	30mm - 1"	3800
1193	9"	48	30mm - 1"	3800
1194	9"	60	30mm - 1"	3800

 MEDIDAS DESDE 10" HASTA 24"  
POR PEDIDO

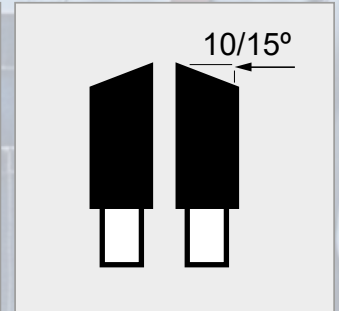
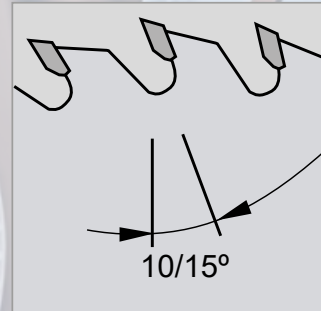

## LINEA VERDE MELAMINA - ALUMINIO



COD.	MEDIDAS	DIENTES	BUJE CENTRAL Y ADAPTADOR	RPM max.
2633	7"	60	22mm - 5/8"	8500
2634	10"	80	30mm - 1"	3800
2635	12"	96	30mm - 1"	3800
2636	14"	108	30mm - 1"	3800

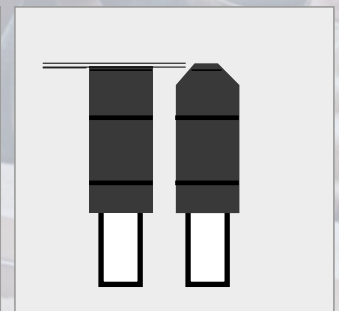
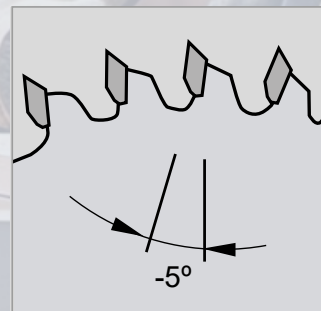

[www.engros.com.ar](http://www.engros.com.ar)



engrosdistribuidora



engros.distribuidora

Calle La Portada 3951, BERISSO 1923

 221 5220273



# TIBURÓN



## SIERRA COPA CARBURO DE TUNGSTENO

**TN100** 33MM

**TN101** 43MM

**TN102** 53MM

**TN103** 67MM

**TN104** 73MM

**TN105** 83MM

**TN106** **SOPORTE  
P/COPA**

**TN107** **MECHA GUÍA  
P/COPA**



Mecha guía y Soporte Universal

Ideales para baldosones, concreto, ladrillo, pisos de cemento, tejas, etc.

**NUEVO**

**TN108** **MUELA  
DIAMANTADA  
DOBLE RUEDA  
TIBURÓN ©**  
Ø 115

Copa diamantada doble hilera para máquinas de mano, para desbaste de cementicios, cerámicos y graníticos.

4 1/2'

115 mm

buje central 30 mm

RPM max. 13500.



PRESENTACIÓN  
COMERCIAL



[www.engros.com.ar](http://www.engros.com.ar)



engrosdistribuidora



engros.distribuidora

Calle La Portada 3951, BERISSO 1923

221 5220273

# NIVELES WESTON®

CERTIFIED MANUFACTURER MADE TO INTERNATIONAL STANDARD ISO 9002



**NUEVO**

## NIVEL ALTO IMPACTO T/AUSTRIA WESTON®

**WE400** 40 CM

**WE401** 60 CM

Fabricado en material de alto impacto, súper resistente a quebraduras y pérdida de forma. Gotas lumínicas de gran tamaño con tornillo de regulación.

## NIVEL DE AL. SPECIAL C/GONIOMETRO WESTON®

**WE402** 30 CM.

**WE403** 40 CM.

**WE404** 50 CM.

**WE405** 60 CM.

**WE406** 120CM.

Fabricado en perfil de aluminio anodizado y rectificado en su base. Incorpora tres ampollas: Horizontal, vertical y goniometro.

## NIVEL PLÁSTICO T/ MINOR WESTON®

**WE407** 40 CM.

**WE408** 50 CM.

**WE409** 60 CM.

Nivel de cuerpo plástico de alto impacto con tres gotas tubulares lumínicas protegidas, escala milimetrada, dúctil liviano, resistente a la torsión.

## NIVEL PLÁSTICO DE BOLSILLO MAGNÉTICO

**WE410** 23 CM.

Nivel cuerpo plástico y base magnética con tres gotas tubulares lumínicas. Económico, útil y de fácil lectura.

[www.engros.com.ar](http://www.engros.com.ar)



engrosdistribuidora



engros.distribuidora

Calle La Portada 3951, BERISSO 1923

221 5220273

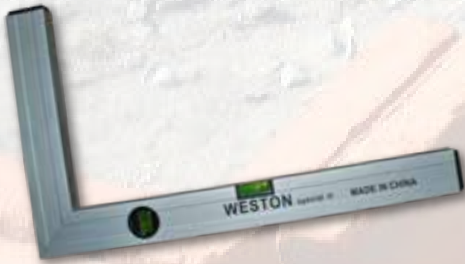

## ESCUADRA ALUMINIO WESTON C/ NIVEL

**WE100** 30X50 CM

Fabricada con aluminio anodizado, incorpora dos ampollas: Horizontal y vertical.

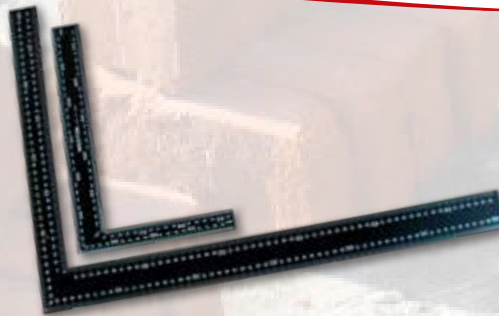

## ESCUADRA ALBAÑIL HIERRO

**WE101** 300 MM.

**WE102** 600 MM.

Fabricado en acero resistente. Graduación métrica.



## ESCUADRA CARPINTERO WESTON C/MET.

- WE103** 20 CM. Mango de aluminio y lámina
- WE104** 25 CM. milimetrada
- WE105** 30 CM. de chapa pintada en epoxi.
- WE106** 35 CM.
- WE107** 40 CM.

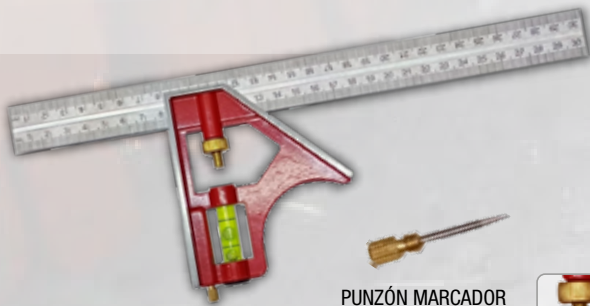

PUNZÓN MARCADOR



TUERCA REGULE MOVILIDAD

## ESCUADRA CARPINTERO 12" MANGO MOVIL

**WE108**

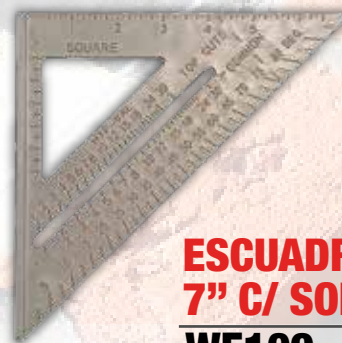

## ESCUADRA TRIÁNGULO 7" C/ SOMBRERO

**WE109**



## FALSA ESCUADRA CUERPO METÁLICO

**WE200** 8'

**WE201** 10'

**WE202** 12'

**NUEVOS**



**WE301**



**WE302**

## LÁPIZ CARPINTERO PROFESIONAL VTA. X 12 U

**WE301** 180 MM X UD

**WE302** 180 MM imp.



# biassoni

HERRAMIENTAS PROFESIONALES



## PALAS



Código      Unidad x Bulto

**PA02**      6

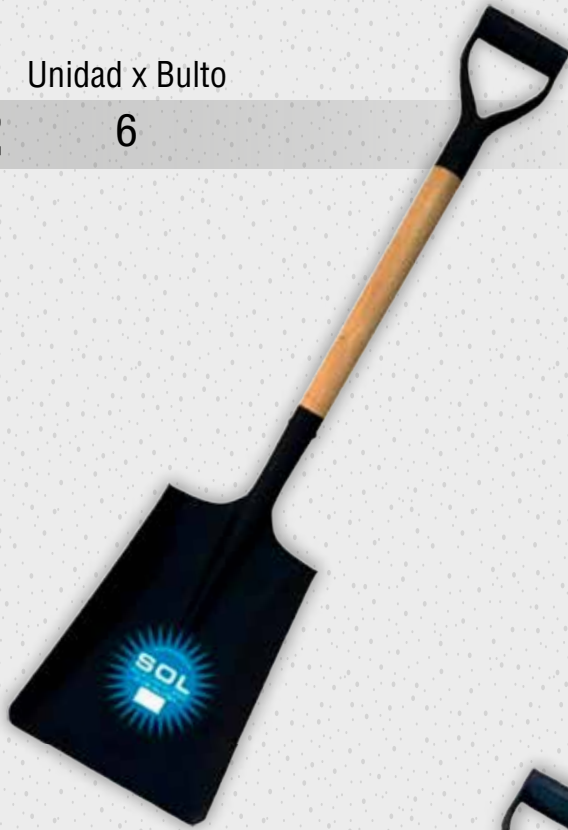

### **PALA ANCHA ESTAMPADA**

**CABO CORTO MADERA**

**Y EMPUÑADURA MONOCOMPONENTE**



A	B	C	D		Peso
1035	212	242	310	6	1732

Ideales para carga de tierra, escombros, piedra y arena

Código      Unidad x Bulto

**PP02**      6



### **PALA PUNTA ESTAMPADA**

**CABO CORTO MADERA**

**Y EMPUÑADURA MONOCOMPONENTE**



A	B	C	D		Peso
1035	175	148	320	6	1412

Ideales para hacer pozos y sanjeados

**75**  
AÑOS  
FABRICANDO EN ARGENTINA

[www.engros.com.ar](http://www.engros.com.ar)



engrosdistribuidora



engros.distribuidora

Calle La Portada 3951, BERISSO 1923



221 5220273

## PA01

**ANCHA**  
CABO HIERRO  
70 CM  
LARGO  
TOTAL 1 M

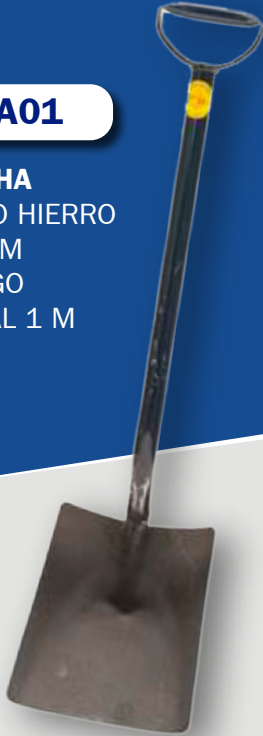

## PP01

**PUNTA**  
CABO HIERRO  
70 CM  
LARGO  
TOTAL 1 M



## PP03

**POCERO**  
CABO LARGO  
HIERRO 1,50 M  
TOTAL 1,80 M



METALÚRGICA  
**FG**

## CP01

**CABO HIERRO**  
UNIV. 70 CM  
PALA/HORQUILLA

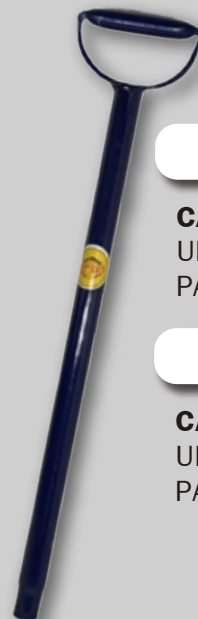

## CP02

**CABO HIERRO**  
UNIV. 150 CM  
PALA/HORQUILLA

## SY01

**SACA YUYO  
Y MALEZAS**  
METÁLICO  
LARGO  
93 CM



## AH12

**AZADA**  
CABO HIERRO  
1.2 MT



PALAS HOYERAS

**PH01**

FIJA  
CUCHARA 25 CM

**PH02**

MOVIL  
CUCHARA 25 CM

**PH03**

MINI MOVIL  
CUCHARA 12 CM



**PB10**

10 CM

**PB15**

15 CM

**PB20**

20 CM

**PB25**

25 CM

BARRENO

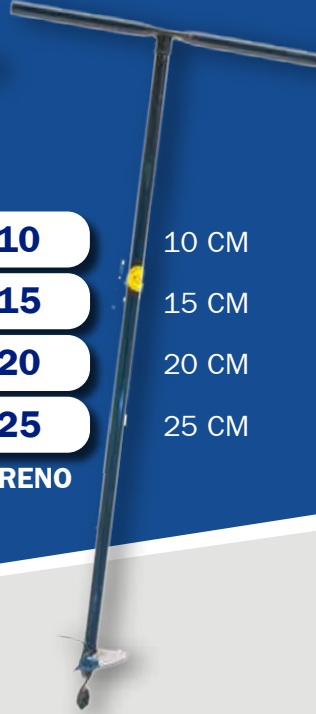

**PT06**

PALA  
TIJERA  
CABO  
HIERRO



**PP04**

PROLONGACION  
PALA HOYERA  
Y BARRENO



METALÚRGICA

**FG**

HORQUILLAS

**H410**

1 M

**H415**

1,5 M

4 PÚAS  
CABO  
HIERRO



**H610**

1 M

**H615**

1,5 M

6 PÚAS  
CABO  
HIERRO





# ZORRAS y ACCESORIOS



## ZORRAS

- ZN01** N° 1 CERRADA 1.15 MT.
- ZN02** N° 2 ABIERTA 1.40 MT.
- ZN02N** N° 2 ABIERTA 1.40 MT. R. NEUMÁTICA
- ZN03** N° 3 CERRADA CURVA 1.40 MT.
- ZN03N** N° 3 CERRADA CURVA 1.40 MT. R. NEUMÁTICA

## RUEDAS P/

- RZN01** ZORRA NEUMÁTICA BUJE P. DESPLAZADO 260\*80\*16
- RZN02** ZORRA NEUMÁTICA BUJE P. CENTRADO 260\*80\*19
- RZP01** ZORRA Y G. ELECT. 150 MM REF. PP Y PVC
- RZP02** ZORRA Y G. ELECT. 175 MM REF. PP Y PVC
- RZP03** ZORRA Y G. ELECT. 200 MM REF. PP Y PVC



**RZN01**



**RZN02**



**RZP01**

**RZP02**

**RZP03**



# CARROS y CARRETILLAS



## CARRO CHANGARÍN CERRADO RUEDAS NEUMÁTICAS

Art. 2592

200  KG

CAPACIDAD DE CARGA	200 Kg
DIMENSIONES	
ALTO	1,3 M
ANCHO	35 cm
PROFUNDIDAD DE BASE	22,5 cm
RUEDA NEUMÁTICA	25 cm

IVA 10,5 %

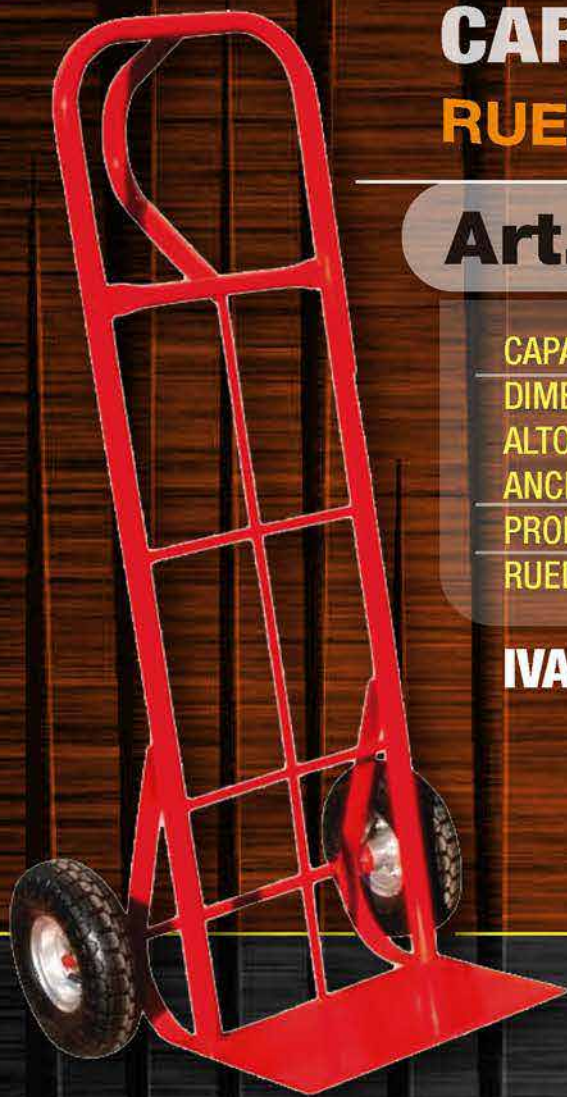

CRN100

100  KG

CAPACIDAD DE CARGA	100 Kg - 220,46lb
CAPACIDAD DE ARENA	3,5CBF - 0.099m3
BATEA/BANDEJA	metal galvanizado 0,8mm
CAÑOS	25 mm x 1,2 mm
DIMENSIONES	1300mm x 620 mm x 580 mm
PESO	9,5 Kg - 20,9lb



IVA 10,5 %

FUNCIÓN:  
Traslado/recolección de materiales

**CARRETILLA  
GALVANIZADA**  
RUEDA NEUMÁTICA

[www.engros.com.ar](http://www.engros.com.ar)



engrosdistribuidora

Calle La Portada 3951, BERISSO 1923

 221 5220273



# CARRETILLAS y ACCESORIOS



**CPC01**



**CPN02**



**PCZ01**



## CARRETILLAS PLÁSTICAS NACIONALES CON CHASIS ENTERO EN UNA SOLA PIEZA CINCADO

- CPC01 COLOR 90 LT. RUEDA PLÁSTICA
- CPC02 COLOR 90 LT. RUEDA NEUMÁTICA
- PCZ01 PUÑO PLÁSTICO P/ CARR. Y ZORRA 120X30

- CPN01 NEGRA 90 LT. RUEDA PLÁSTICA
- CPN02 NEGRA 90 LT. RUEDA NEUMÁTICA



**RCN01**



**RCN02**



**RCP01**



**RHN01**



**RHN02**



**RHP01**

### RUEDAS P/

- RCN01 CARRETILLA NEUMÁTICA 360\*80\*17
- RCN02 CARRETILLA NEUM. 360\*80\*17 4 TELAS
- RCP01 CARRETILLA PLÁSTICA 360\*60\*17
- RHN01 HORMIGONERA NEUMÁTICA 360\*80\*27
- RHN02 HORMIGONERA NEUM. 360\*80\*27 4 TELAS
- RHP01 HORMIGONERA PLÁSTICA 360\*60\*27



## CORTAHIERRO FORJADO

- TH0400 19 MM X 20 CM
- TH0401 19 MM X 25 CM
- TH0402 19 MM X 30 CM
- TH0403 19 MM X 35 CM
- TH0404 19 MM X 40 CM

## PUNTA FORJADA

- TH0500 19 MM X 20 CM
- TH0501 19 MM X 25 CM
- TH0502 19 MM X 30 CM
- TH0503 19 MM X 35 CM
- TH0504 19 MM X 40 CM

## GRINFA FORJADA

- TH0600 6 MM
- TH0601 8 MM
- TH0602 10 MM
- TH0603 12 MM
- TH0604 14 MM
- TH0605 16 MM
- TH0606 18 MM
- TH0607 20 MM

## CLAVO REGLA ALBANIL

- TH0900 15 CM
- TH0901 22 CM

## BARRETA FORJADA

- TH0700 19 MM X 40 CM
- TH0701 19 MM X 50 CM
- TH0702 19 MM X 60 CM
- TH0703 19 MM X 70 CM
- TH0704 19 MM X 80 CM
- TH0705 19 MM X 90 CM
- TH0706 19 MM X 100 CM

## BARRETÍN CAJONERO

- TH0800 14 MM X 50 CM

## MAZA MINERA C/ CABO

<b>TH0500</b>	0.500 KG	<b>TH1750</b>	1.75 KG
<b>TH0750</b>	0.750 KG	<b>TH2000</b>	2.0 KG
<b>TH1000</b>	1.00 KG	<b>TH3000</b>	3.0 KG
<b>TH1250</b>	1.25 KG	<b>TH4000</b>	4.0 KG
<b>TH1500</b>	1.50 KG	<b>TH5000</b>	5.0 KG



## PICO PUNTA Y PALA C/ CABO

**TH0300** 75 MM



## HACHA

<b>TH0200</b>	DE TUMBA 2.5 KG C/ CABO
<b>TH0201</b>	DE RAJAR 3.0 KG C/ CABO
<b>TH0202</b>	DE MANO 700 GRS C/ CABO



PALA MARTILLO

SOLDADOR

PALA HACHA

PICO PALA



## HACHUELA

<b>TH0100</b>	ALBAÑIL PALA-HACHA
<b>TH0101</b>	ALBAÑIL PALA-MARTILLO
<b>TH0102</b>	AZULEJISTA PICO-PALA
<b>TH0103</b>	SOLDADOR

# ALBAÑILERÍA



## CUCHARA SOLDADA P/ ALBAÑIL

- 614** 5 ½'

---

- 615** 6'

---

- 616** 7'

---

- 617** 7' MOCHA

---

- 618** 8'

---

- 619** 8' MOCHA



## BALDE ALBAÑIL REFORZADO EN2219



DESCUENTO  
**10%**  
x 10 doc.



## 1113 PLOMADA TRAZADORA CHOCLA C/TIZA Y NIVEL

# grilon

**EN2593**  
TANZA PARA ALBAÑIL  
0.80 MM. X 100 METROS  
CAJA x 6 Uds.



## PLOMADA TORNEADA

<b>MM200</b>	200 gr
<b>MM300</b>	300 gr
<b>MM400</b>	400 gr
<b>MM500</b>	500 gr
<b>MM700</b>	700 gr



## TANZA ARATY

**EN2594** 0,80 MM X 100 M  
CAJA x 10 Uds.

[www.engros.com.ar](http://www.engros.com.ar)



engrosdistribuidora



engros.distribuidora

Calle La Portada 3951, BERISSO 1923



221 5220273

# FRATACHOS



**LIJADOR** 2805 | 2806 | 2807



**PLASTICO** 2844 | 2845 | 2846



**ALGARROBO** 2850 | 2851 | 2852



**PINO NACIONAL** 2847 | 2848 | 2849



2805 FRATACHO LIJADOR GRANO FINO (CAJA X 8 UD)

2806 FRATACHO LIJADOR GRANO MEDIANO (CAJA X 8 UD)

2807 FRATACHO LIJADOR GRANO GRUESO (CAJA X 8 UD)

2844 FRATACHO PLASTICO DE 20 CM (PAQUETE 20 UD)

2845 FRATACHO PLASTICO DE 25 CM (PAQUETE 20 UD)

2846 FRATACHO PLASTICO DE 30 CM (PAQUETE 20 UD)

2850 FRATACHO ALGARROBO NACIONAL 30 CM (PAQUETE X 12 UD)

2851 FRATACHO ALGARROBO NACIONAL 35 CM (PAQUETE X 12 UD)

2852 FRATACHO ALGARROBO NACIONAL 40 CM (PAQUETE X 12 UD)

2847 FRATACHO PINO NACIONAL 30 CM (PAQUETE X 12 UD)

2848 FRATACHO PINO NACIONAL 35 CM (PAQUETE X 12 UD)

2849 FRATACHO PINO NACIONAL 40 CM (PAQUETE X 12 UD)



### CANDADO BRONCEADO

CAJA X

<b>BN532</b>	32MM. C/3 LLAVES	6
<b>BN538</b>	38MM. C/3 LLAVES	6
<b>BN550</b>	50MM. C/3 LLAVES	6



### CANDADO GOLDEN PESADO EN BLISTER

CAJA X

<b>BN632</b>	32 MM	12
<b>BN638</b>	38 MM	12
<b>BN650</b>	50 MM	12
<b>BN663</b>	63 MM	12



### CANDADO BDO PESADO ARO LARGO

CAJA X

<b>BN232L</b>	32 MM	6
<b>BN238L</b>	38 MM	6
<b>BN250L</b>	50 MM	6



### CANDADO BRONCE NUMÉRICO 3 DIG.

CAJA X

<b>BN720</b>	20MM	12
<b>BN730</b>	30MM	12



### CANDADO VALIJERO NUMÉRICO COLOR

CAJA X

<b>BN793</b>	30MM	12
--------------	------	----



### CANDADO ACERADO PESADO

<b>BN832</b>	32MM	6
<b>BN838</b>	38MM	6
<b>BN850</b>	50MM	6
<b>BN863</b>	63MM	6



### CANDADO ACERO INOX BLINDADO ALTA SEGURIDAD

<b>BN940</b>	40MM	12
<b>BN950</b>	50MM	12



### CANDADO ACERO RECTANGULAR ALTA SEGURIDAD

<b>BN980</b>	80MM	12
--------------	------	----



### CANDADO DOBLE PALETA REFORZADO

<b>BN440</b>	40MM	12
<b>BN455</b>	55MM	12



### COFRE METÁLICO PORTAVALORES

<b>BN152</b>	Nº 1	152X115X80
<b>BN200</b>	Nº 2	200X160X90
<b>BN250</b>	Nº 3	250X180X90
<b>BN300</b>	Nº 4	300X240X90



# CAJAS HERRAMIENTAS PREMIUM

SILVER tools  
S H A D O W



**CH100** 12" CAJA HERR.PLAST.  
**CH101** 16" C/BANDEJA Y  
**CH102** 19" GAVETA EN TAPA

**CH103** 17" CAJA HERR.PROF.  
**CH104** 24" C/BANDEJA Y GAVETERO



SILVER tools  
S H A D O W

**CC100**  
CAJA-CARRO HERR  
3 EN 1 C/RUEDAS

[www.engros.com.ar](http://www.engros.com.ar)



engrosdistribuidora



engros.distribuidora

Calle La Portada 3951, BERISSO 1923



221 5220273

# GAVETEROS Y MALETINES

SILVER tools  
S H A D O W



**CG100**  
**CAJA-GAVETERO**  
MONSTER 9 DIV P/CARRO 3 en 1 (CC100)



**CG101**  
**CAJA-GAVETERO**  
PROFESIONAL 10 DIV. REMOVIBLES



**CG102**  
**CAJA-GAVETERO**  
MODELO MALETIN 12.5'



**CG103**  
**CAJA-GAVETERO CRISTAL**  
TRANSPARENTE 11 DIV.  
19X12.5X3.5



**CG104**  
**CAJA-GAV. CRISTAL**  
TRANSP. 16 DIV.  
22X12.5X3



**CB100**  
**CAJA-BOTIQUÍN**  
5 DIV. REMOVIBLES  
26X13X6



**CG105**  
**CAJA-GAVETERO**  
5 DIV. REMOVIBLES  
26X13X6



**CG106**  
**CAJA-GAVETERO**  
11 DIV. REMOVIBLES  
24X21X6



**CG107**  
**CAJA-GAVETERO**  
23 DIV. REMOVIBLES  
36X26X6



**CM101**  
**CAJA MALETIN MAGNUM**  
P/ TALADRO y AMOLADORA  
35X34X15

[www.engros.com.ar](http://www.engros.com.ar)



engrosdistribuidora



engros.distribuidora

Calle La Portada 3951, BERISSO 1923



221 5220273

# CEPILLOS DE ACERO



PRESENTACIÓN  
COMERCIAL



**CEPILLO DE ACERO  
PARA AMOLADORA  
DE BANCO  
BRONCEADO  
CIRCULAR RIZADO**

**CA100** 4 X 1  
**CA101** 5 X 1  
**CA102** 6 X 1  
**CA103** 7 X 1  
**CA104** 8 X 1

**CEPILLOS DE  
ACERO PARA  
AMOLADORA  
ANGULAR C/  
TUERCA M14**



**CA200** CIRCULAR  
RIZADO 4"



**CA201** CIRCULAR  
TRENZADO 4"



**CA202** COPA RIZADO 3"  
**CA203** COPA RIZADO 4"  
**CA204** COPA RIZADO 5"



**CA205** COPA TRENZADO 3"  
**CA206** COPA TRENZADO 4"

**CEPILLOS DE  
ACERO PARA  
TALADRO C/  
PERNO**

CIRCULAR RIZADO



**CA300** 2"  
**CA301** 3"  
**CA302** 4"

COPA RIZADO



**CA303** 2"  
**CA304** 3"

DESCARBONIZADOR



**CA305** 12 MM  
**CA306** 19 MM  
**CA307** 25 MM  
**CA308** 30 MM

**CEPILLOS DE  
ACERO DE MANO**



**CA400**  
CURVO MANGO PLÁSTICO

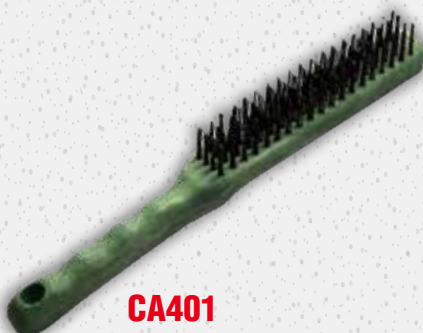

**CA401**  
CON MANGO 4 X 19



**CA402**  
SIN MANGO 6 X 19

# CUTTERS **TOOLMAK**®



## CUTTER



**CT100** METÁLICO  
18 MM MANGO  
ERGONÓMICO

**CT101** REFORZADO  
18 MM GUÍA  
METÁLICA

**CT102** RETRÁCTIL  
18 MM EN  
BLISTER



**CT104** PLAST. 18 MM  
EN BLISTER  
X 12 UDS.

**CT105** TRAPEZOIDAL  
REMOVING  
P/VIDRIOS

**CT106** HOJA  
RECTANGULAR  
18MM BLISTER  
X 10 UDS.

**CT107** HOJA  
TRAPEZOIDAL  
BLISTER  
X 10 UDS.



**CT108** CORTAVIDRIO  
C/RUEDA JOBO

**CT109** CUTTER PLEGABLE  
TRAPEDOIZAL  
C/REP. TMK  
X 12 UDS.

**CT110** CUTTER METÁLICO  
ART. PROF.  
C/REP. TMK  
X 12 UDS.



# TIJERAS

# TOOLMAK®



## TIJERAS

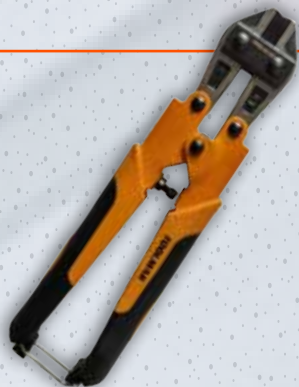

**TJ100** CORTA PERNO  
Y ALAMBRE  
PROF. CR-V 8'

**CHAPISTA  
AVIACIÓN** **TJ101** DERECHA  
**TJ102** IZQUIERDA  
**TJ103** RECTA



**HOJALATERO  
PROF.  
C/ RESORTE** **TJ104** 250MM  
**TJ105** 300MM



**TJ106** P/CORTAR  
CAÑOS DE PVC  
42MM



**TJ107**  
COSTURA  
PROFESIONAL 8'



**TJ108** OJALADORA 6'  
CON OJALES



**TJ109** PROFESIONAL TMK  
CORTA CAÑO DE PVC  
3 A 42 MM



**PJ124** DE PODA 8'  
CORTE  
CLÁSICO



**PJ125** CORTA  
CERCO 12'  
CABO MADERA

[www.engros.com.ar](http://www.engros.com.ar)



engrosdistribuidora



engros.distribuidora

Calle La Portada 3951, BERISSO 1923



221 5220273

# ALICATES y PINZAS

## PROFESIONALES



### ALICATES



**ALI100** 6" SAT.  
**ALI101** 7" SAT.  
CORTE OBLICUO



**ALI102** 6" SAT.  
MEDIA CAÑA CURVA



**ALI103** 6" SAT.  
**ALI104** 8" SAT.  
MEDIA CAÑA

### ALICATES MINI



**ALI105**  
4 ½ CORTE  
OBLICUO



**ALI106**  
4 ½ MEDIA  
CAÑA



**ALI107**  
4 ½ PUNTA  
CHATA



**ALI108**  
4 ½ ROSARIO

### JUEGO ALICATES ELECTRÓNICA



**JPE100**  
4 PCS TMK

### PINZAS



**PIN100**  
APRETA  
TERMINALES



**PIN104**  
PELACABLE  
PLÁSTICO  
T/SKUM



**PIN111**  
PELACABLE  
AUTOMÁTICA  
FRONTAL TMK



**PIN101**  
CORTA CERÁMICA  
C/R.WIDIA

# PINZAS y TENAZAS

## PROFESIONALES



### PINZAS



**PIN102**  
DE FUERZA X  
10" CON GRIP  
TMK



**PIN103**  
DE MAZA  
300 AMP.



**PIN105**  
PORTAELECTRODOS  
500 AMP.



**PIN106**  
SACABOCADOS  
CROMADA DE 8"



**PIN107**  
SEGER C/4 PTAS  
INTERC.



**PIN108** 7" SAT.  
**PIN109** 8" SAT.  
UNIVERSAL PROF.



**PIN110**  
PICOLORO DOBLE  
CREMALLERA 10"  
T/KNIPEX **TMK**

### TENAZAS



**TEN100** 9" SAT. C/GRIP  
**TEN101** 11" SAT. C/GRIP  
ARMADOR



**TEN102** 7" SAT. C/GRIP  
**TEN103** 8" SAT. C/GRIP  
CARPINTERO

# DESTORNILLADORES

HIGH QUALITY

# TOOLMAK®



## PROFESIONALES ergonómico **PHILLIPS**



<b>DPH100</b>	3 X 75	<b>DPH106</b>	5 X 100
<b>DPH101</b>	4 X 50	<b>DPH107</b>	5 X 125
<b>DPH102</b>	4 X 75	<b>DPH108</b>	5 X 150
<b>DPH103</b>	4 X 100	<b>DPH109</b>	6 X 100
<b>DPH104</b>	4 X 125	<b>DPH110</b>	6 X 150
<b>DPH105</b>	5 X 75		

PRESENTACIÓN  
COMERCIAL  
caja x 12  
VENTA MÍNIMA 6 UNIDADES



<b>DPL100</b>	3 X 75	<b>DPL106</b>	5 X 125
<b>DPL101</b>	4 X 75	<b>DPL107</b>	5 X 150
<b>DPL102</b>	4 X 100	<b>DPL108</b>	6 X 100
<b>DPL103</b>	4 X 125	<b>DPL109</b>	6 X 125
<b>DPL104</b>	5 X 75	<b>DPL110</b>	6 X 150
<b>DPL105</b>	5 X 100		

## PROFESIONALES ergonómico **PLANO**



PRESENTACIÓN  
COMERCIAL  
caja x 12  
VENTA MÍNIMA  
6 UNIDADES



## EXTRACTOR TORNILLOS EXT100

X 5PZAS 6-8-11-14-18

## DESTORNILLADOR BUSCAPOLO **ECO**

DPL118 X 12 UD

## BUSCAPOLO PROF. **CHICO TMK**

DPL119 X 12 UD

## **GRANDE TMK**

DPL120 X 12 UD

## DESTORNILLADOR PTA. INTERCAMBIABLE

**AISLADO TMK**

DPI100 X 12 UD

# JUEGOS y PUNTAS DE ATORNILLAR

HIGH QUALITY



## PUNTAS PHILLIPS

- PPH100 PH1 X 50 MM
- PPH101 PH2 X 25 MM
- PPH102 PH2 X 50 MM

PRESENTACIÓN:  
BLISTER X 10 UDS.



## PUNTAS PLANA

- PPL100 25MM DE 3 MM.
- PPL101 25MM DE 4 MM.
- PPL102 25MM DE 4.5 MM.
- PPL103 25MM DE 5.5 MM.
- PPL104 25MM DE 6.5 MM.

**PLANA TORX POZIDRIVE**  
PRESENTACIÓN COMERCIAL  
BLISTER X 10 UDS.



## PUNTAS TORX

- PTX100 25MM TX-10
- PTX101 25MM TX-15
- PTX102 25MM TX-20
- PTX103 25MM TX-25
- PTX104 25MM TX-30



## PUNTAS POZIDRIVE

- PPD100 25MM NRO 0
- PPD101 25MM NRO 1
- PPD102 25MM NRO 2
- PPD103 25MM NRO 3



## PUNTAS MONTADAS

- PM0100 CHICAS 3MM X 5PIEZAS
- PM0101 GRANDES 6MM X 5PIEZAS

## JUEGOS

**JNP100**  
NZK-26 PCS  
DEST TIPO T  
PUNTAS  
TUBOS



**JNP103**  
NZK-31 PCS  
DEST C/CRIQUE  
Y PUNTAS  
PRECISION



PRESENTACIÓN COMERCIAL

**JNP101**  
NZK-28 PCS  
LLAVE CRIQUE  
PUNTAS  
TUBOS



**JNP102**  
NZK-30 PCS  
DEST  
C/ACOPLE  
RAP Y PUNTAS



[www.engros.com.ar](http://www.engros.com.ar)



engrosdistribuidora



engros.distribuidora

Calle La Portada 3951, BERISSO 1923



221 5220273

# BOCALLAVES



## BOCALLAVE CR-VAN



### MILÍMETROS

<b>BOC100</b>	8	<b>BOC112</b>	20
<b>BOC101</b>	9	<b>BOC113</b>	21
<b>BOC102</b>	10	<b>BOC114</b>	22
<b>BOC103</b>	11	<b>BOC115</b>	23
<b>BOC104</b>	12	<b>BOC116</b>	24
<b>BOC105</b>	13	<b>BOC117</b>	25
<b>BOC106</b>	14	<b>BOC118</b>	26
<b>BOC107</b>	15	<b>BOC119</b>	27
<b>BOC108</b>	16	<b>BOC120</b>	28
<b>BOC109</b>	17	<b>BOC121</b>	29
<b>BOC110</b>	18	<b>BOC122</b>	30
<b>BOC111</b>	19	<b>BOC123</b>	32

### PULGADAS

<b>BOC200</b>	5/16
<b>BOC201</b>	3/8
<b>BOC202</b>	7/16
<b>BOC203</b>	1/2
<b>BOC204</b>	9/16
<b>BOC205</b>	5/8
<b>BOC206</b>	11/16
<b>BOC207</b>	3/4
<b>BOC208</b>	13/16
<b>BOC209</b>	7/8
<b>BOC210</b>	1

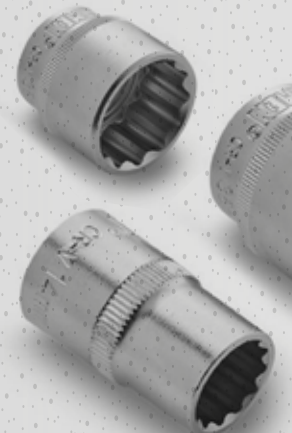

## BOC-BARRA EXTENSIÓN



**BOC304** X 75MM 1/2 CR-VAN  
**BOC305** X 125MM 1/2 CR-VAN  
**BOC306** X 250MM 1/2 CR-VAN



## BOC-UNIÓN UNIVERSAL 1/2" CR-VAN

**BOC307**

## BOQUILLA MAGNÉTICA



TODAS LAS BOQUILLAS VIENEN EN BLISTER X 5 UNIDADES

**BOQ100** 3/8 X 65MM BLISTER X 5 UD.  
**BOQ101** 5/16 X 65MM BLISTER X 5 UD.  
**BOQ102** 7/16 X 65MM BLISTER X 5 UD.



# LLAVES



## COMBINADAS FORJADAS CR-VAN



### MILÍMETROS

LLA200 6	LLA207 13	LLA214 20	LLA221 27
LLA201 7	LLA208 14	LLA215 21	LLA222 28
LLA202 8	LLA209 15	LLA216 22	LLA223 30
LLA203 9	LLA210 16	LLA217 23	LLA224 32
LLA204 10	LLA211 17	LLA218 24	
LLA205 11	LLA212 18	LLA219 25	
LLA206 12	LLA213 19	LLA220 26	

### PULGADAS

LLA300 1/4	LLA307 11/16
LLA301 5/16	LLA308 3/4
LLA302 3/8	LLA309 13/16
LLA303 7/16	LLA310 7/8
LLA304 1/2	LLA311 15/16
LLA305 9/16	LLA312 1
LLA306 5/8	

## T PROF. SATINADAS NEGRAS

### MILÍMETROS

LLA400 6
LLA401 7
LLA402 8
LLA403 9
LLA404 10
LLA405 11
LLA406 12
LLA407 13
LLA408 14
LLA409 16
LLA410 17
LLA411 19

### PULGADAS

LLA500 1/4
LLA501 5/16
LLA502 3/8
LLA503 7/16
LLA504 1/2
LLA505 9/16
LLA506 5/8
LLA507 3/4



## AJUSTABLE PROFESIONAL

- LLA132 X 8" C/ESCALA
- LLA133 X 10" C/ESCALA



## T JUEGO 21 PZAS. PUNTAS Y TUBOS.

LLA134



## LLAVE P/ MANDRIL

- LLA135 10MM. 3/8 X 24
- LLA136 13MM. 1/2 X 20



# LLAVES

**TOOLMAK**  
**Nazka**<sup>®</sup>



## ALLEN CR-VAN

- LLA100** 1.5 MM
- LLA101** 2.0 MM
- LLA102** 2.5 MM
- LLA103** 3.0 MM
- LLA104** 3.5 MM
- LLA105** 4.0 MM
- LLA106** 4.5 MM
- LLA107** 5.0 MM
- LLA108** 5.5 MM
- LLA109** 6.0 MM
- LLA110** 7.0 MM
- LLA111** 8.0 MM
- LLA112** 9.0 MM
- LLA113** 10 MM
- LLA114** 11 MM
- LLA115** 12 MM



## ALLEN JUEGO



- LLA116** 8 PZAS. CROMADAS MM-SAE
- LLA117** 10 PZAS MM (1.5 A 10 MM)
- LLA118** 25 PZAS. MM-SAE.



## ALLEN BALL JUEGO

- LLA119** CR-VAN 8 PZAS PLEG.T/ NAVAJA
- LLA120** LARGA CR-VAN 9 PZAS CARTUCHERA



## TORX JUEGO

- LLA121** 8 PZAS PLEG. T/ NAVAJA
- LLA122** 9 PZAS CARTUCHERA

## AJUSTABLE P/ AMOLADORA

**LLA130**



## CRUZ PROFESIONAL FIJA

**LLA131**

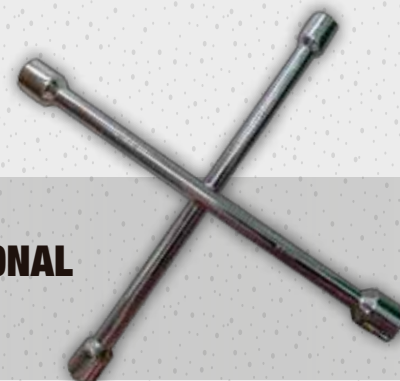

# MARTILLOS y COPAS

**TOOLMAK**<sup>®</sup>  
**Nazka**<sup>®</sup>



## MARTILLO CARPINTERO PROF.

**MC100** 18 MM. **MC103** 25 MM. CAJA X 6  
**MC101** 20 MM. **MC104** 28 MM. CAJA X 6  
**MC102** 22 MM. **MC105** 30 MM. CAJA X 6



## MARTILLO BOLITA

**MB100** 227 GR. (1/2LB)  
**MB101** 340 GR. (3/4LB)  
**MB102** 454 GR. (1 LB)



**MG101** 27MM CABO  
CAJA X 6 MADERA



## MARTILLO GALPONERO

**MG100** 27MM CABO  
CAJA X 6 FIBRA BICOLOR



**SC101** HIERRO  
P/MAD 11 PZAS.  
(19-64MM)



## MACETA DE GOMA

**MG102** CAJA X 6  
500 GR.



## MAZA DE GOMA

**MG103** CAJA X 6  
MANGO FIBRA 16 Oz 453G *TMK*

[www.engros.com.ar](http://www.engros.com.ar)



engrosdistribuidora



engros.distribuidora

Calle La Portada 3951, BERISSO 1923



221 5220273

# PISTOLA y APLICADORES

**TOOLMAK**<sup>®</sup>  
**Nazka**<sup>®</sup>



**PISTOLA  
APLICADORA**

**PT100**  
CERRADA 15'  
AL. P/ SACHET



**PT101**  
MODELO  
SUPERIOR



**PT102**  
REFORZADA



**PT103**  
ESQUELETOR



PRESENTACIÓN  
COMERCIAL



**PISTOLA PT106**  
CON TANQUE  
P/LARGO  
NEUMATICA



**PT203**  
**ENGRASADOR**  
MANUAL A PALANCA 400 CC



**PISTOLA  
HOT MELT  
ENCOLADORA**

**PT108** 10/20 W  
**PT109** 40/60 W



**ADHESIVO  
EN BARRA  
TTE X 1KG**

**PT200** FINO  
**PT201** GRUESO



**PT202**  
**ACEITERA**  
T/ PISTOLA  
METÁLICA  
250 CC



**PT204**  
**PULVERIZADOR**  
T/ PISTOLA  
REFORZADO  
1.50 LTS

[www.engros.com.ar](http://www.engros.com.ar)



engrosdistribuidora



engros.distribuidora

Calle La Portada 3951, BERISSO 1923



221 5220273

# PRENSAS y ESCUADRAS

**TOOLMAK**<sup>®</sup>  
**Nazka**<sup>®</sup>



## PRENSA RÁPIDA



- PR100** T/PINZA MANUAL 5`
- PR101** T/PINZA MANUAL 7 1/4`
- PR102** T/PINZA MANUAL 9`



- PR103** T/SARGENTO 12` ( 305MM)
- PR104** T/SARGENTO 16` ( 408MM)
- PR105** T/SARGENTO 24` ( 610MM)



- PG100** TIPO G PLÁSTICA 3`
- PG101** TIPO G PLÁSTICA 4`



- PRENSA**
- PG102** TIPO G METÁLICA DE 3`
  - PG103** TIPO G METÁLICA DE 4`
  - PG104** TIPO G METÁLICA DE 5`
  - PG105** TIPO G METÁLICA DE 6`



- ESQUINERO** **PE100**  
ÁNGULO 90°  
CARPINTERO

## ESCUADRA MAGNÉTICA



- EM100** 3` HASTA 11 KG
- EM101** 4` HASTA 22 KG
- EM102** 4` MULTI ÁNGULO DE 35° A 135°
- EM103** 5` HASTA 34 KG

[www.engros.com.ar](http://www.engros.com.ar)



engrosdistribuidora



engros.distribuidora

Calle La Portada 3951, BERISSO 1923



221 5220273

# SERRUCHOS E INGLETADORAS

**TOOLMAK**  
**Nazka**<sup>®</sup>



## SERRUCHO CARPINTERO CABO MADERA

NE0010	400MM	NE0013	550MM
NE0011	450MM	NE0014	600MM
NE0012	500MM		



## SERRUCHO PROFESIONAL CARPINTERO

SER100	400MM	SER103	550MM
SER101	450MM	SER104	600MM
SER102	500MM		



## SERRUCHO PROFESIONAL COSTILLA

SER105	300 MM
SER106	350 MM



## INGLETADORA PLÁSTICA 30 CM X 14 CM

ING100



## INGLETADORA PLÁSTICA C/ SERRUCHO

ING101



## INGLETADORA C/ SERRUCHO 12 TMK

ING102



[www.engros.com.ar](http://www.engros.com.ar)



engrosdistribuidora



engros.distribuidora

Calle La Portada 3951, BERISSO 1923



221 5220273

# SERRUCHOS

**TOOLMAK**<sup>®</sup>  
**Nazka**<sup>®</sup>



**SERRUCHO DURLERO**  
MANGO ERGONÓMICO  
**SER107**



**SERRUCHO PUNTA 12'**  
MANGO MADERA  
**SER108**

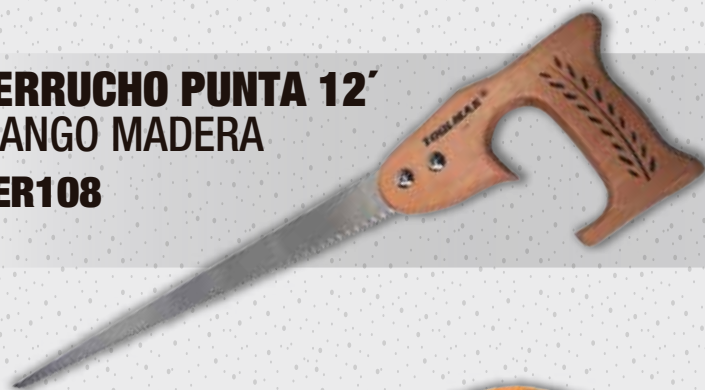

**SERRUCHO PODA**  
**350MM C/ ESTUCHE**  
BLISTER X1  
**SER109**



**SERRUCHO CURVO 13" TMK**  
PODA ALTURA  
**SER110**



**SERRUCHO PODA CURVO 295 MM**  
MANGO MADERA  
**NE0015**



[www.engros.com.ar](http://www.engros.com.ar)



engrosdistribuidora



engros.distribuidora

Calle La Portada 3951, BERISSO 1923



221 5220273

# SIERRAS, FORMONES Y GUBIAS



## ARCO SIERRA T/ PISTOLA PESADO

ARC100



## ARCO SIERRA T/PISTOLA MANGO PLÁSTICO

ARC101



## ARCO DE SIERRA FIJO CABO DE MADERA

ARC102



## ARCO JUNIORS M.PLÁSTICO CON HOJA

ARC103



## ARCO JUNIORS METÁLICO CON HOJA

ARC104



## ARCO REFORZADO P/HOJA SIERRA ROTA

ARC105



## FORMÓN PROF.C/PLÁSTICO

FOR100	6 MM - 1/4"
FOR101	8 MM - 5/16"
FOR102	10MM - 3/8"
FOR103	12MM - 1/2"
FOR104	16MM - 5/8"
FOR105	19MM - 3/4"
FOR106	22MM - 7/8"
FOR107	25MM - 1"
FOR108	32MM - 1 1/4"



## GUBIAS PARA MADERA BLISTER X 8 PZAS

GUB100



[www.engros.com.ar](http://www.engros.com.ar)



engrosdistribuidora



engros.distribuidora

Calle La Portada 3951, BERISSO 1923



221 5220273

# HERRAMIENTAS IMPORTADAS



## ELECTRODOS P. AZUL X KG BRACO

- EPA200** 2.00 MM
- EPA250** 2.50 MM
- EPA325** 3.25 MM



CAJA X 6

### EN700 SOPLETE P/ GAS BUTANO CON ENCENDIDO



CAJA X 28

### EN701 GAS BUTANO EN CARTUCHO 227 GR PACK X 4 UD



### EN702 SOLDADOR PTA LAPIZ 40 WATTS M/PVC BLISTER



### ESTAÑO EN BLISTER

- EN800** AL 33 %
- EN801** AL 40 %
- EN802** AL 50 %
- EN803** AL 60 %

x 10 UD



# HERRAMIENTAS IMPORTADAS

**TOOLMAK**<sup>®</sup>  
**Nazka**<sup>®</sup>



## DISCO FIBRA ABRASIVA 115 CHAUPINT

**DFA115**

CAJA X 10



## DISCO CADENA MOTOSIERRA 115 MM

**DCM115**

CAJA X 25

PRESENTACIÓN  
COMERCIAL



## COPA DIAMANTADA ESCALONADA 20-30-50 MM BRACO

**CD2050**

PRESENTACIÓN  
COMERCIAL



## SOPORTE P/ AMOLADORA CORT. ANG. 45° BRACO

**SA0045**



## CORTACAÑO PROFESIONAL

**EN200** 3 A 30 MM

PRESENTACIÓN  
COMERCIAL



## PESTAÑADORA

**EN201** DE 3/16 A 5/8

PRESENTACIÓN  
COMERCIAL



## ALAMBRE GALVANIZADO

**EN300** N° 16 ROLLO X 20 MTS. CAJA X 6

**EN301** N° 18 ROLLO X 25 MTS. CAJA X 5

**EN302** N° 20 ROLLO X 40 MTS. CAJA X 6

**EN303** N° 22 ROLLO X 60 MTS. CAJA X 6

[www.engros.com.ar](http://www.engros.com.ar)



engrosdistribuidora



engros.distribuidora

Calle La Portada 3951, BERISSO 1923

221 5220273

# HERRAMIENTAS IMPORTADAS

**TOOLMAK**<sup>®</sup>  
**Nazka**<sup>®</sup>



**EN500 ENGRAMPADORA METÁLICA**  
HASTA 14MM PESADA

PRESENTACIÓN  
COMERCIAL

CAJA X 6



## GRAMPAS

LIVIANA X 1000 U    PESADA X 1000 U

<b>EN600</b> 6 MM	<b>EN605</b> 6 MM
<b>EN601</b> 8 MM	<b>EN606</b> 8 MM
<b>EN602</b> 10 MM	<b>EN607</b> 10 MM
<b>EN603</b> 12 MM	<b>EN608</b> 12 MM
<b>EN604</b> 14 MM	<b>EN609</b> 14 MM



CAJA X 50



**TACHAS TB1000 BRONCEADAS**  
**TC1000 CROMADAS**

CAJA X 1000 u

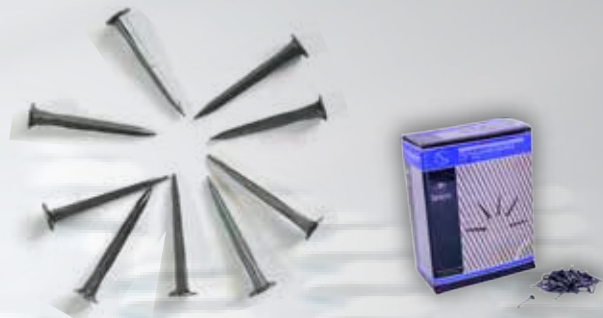

**TACHUELAS AZULADAS TA401** DE 1/2  
**TA402** DE 3/4  
**TA403** DE 5/8

CAJA X 400 G.

CAJA X 4



**MEZCLADO DE PINT. P/ TALADRO**  
100 X 100MM  
**MP100**



**KIT ACCESORIOS DREMEL**  
100 PCS  
**KAD100**



# HERRAMIENTAS IMPORTADAS



## SUCCIONADOR SOPAPA VIDRIO



**SIMPLE 1242**  
30 KG



**DOBLE 1243**  
70 KG



**TRIPLE 1244**  
120 KG

## PIEDRA AFILAR



**MANGUERA** 1013 15 M.  
**ESPIRAL 1/4** 1014 7.5 M



**1082** GUADAÑA 9'



**1084** DOBLE FAZ DE 8

## REMACHADORA



**1144**  
REFORZADA COLOR 4 BOQ KLEBER  
CAJA X 6



**1145**  
PROF. IND. FUNDICION 4 BOQ. KLEBER  
CAJA X 6





# grilon®

Plásticos de Ingeniería

## TANZAS



### Hilo de Nylon para bordeadoras y desmalezadoras:

Desarrolladas con poliamidas de alto peso molecular proporcionando al hilo elevada flexibilidad y mayor resistencia al desgaste por flexión o por fricción.



# grilon®

Plásticos de Ingeniería



CÓDIGO

**TANZA CUADRADA**

CÓDIGO

**TANZA REDONDA**

**TC161**

1.6 MM X 1 KG.

**TR161**

1.6 MM X 1 KG.

**TC201**

2.0 MM X 1 KG.

**TR201**

2.0 MM X 1 KG.

**TC241**

2.4 MM X 1 KG.

**TR241**

2.4 MM X 1 KG.

**TC301**

3.0 MM X 1 KG.

**TR301**

3.0 MM X 1 KG.

[www.engros.com.ar](http://www.engros.com.ar)



engrosdistribuidora



engros.distribuidora

Calle La Portada 3951, BERISSO 1923



221 5220273

# HERRAMIENTAS para PARQUES y Jardines



ACOLCHADO PARA MAYOR  
COMODIDAD DEL OPERADOR



DOBLE CORREA  
PARA MAYOR SEGURIDAD

HEBILLA METÁLICA



APOYO DE CONFORT

COBERTURA DE CAUCHO



IDEAL PARA TRABAJOS  
CONTINUOS Y EXIGENTES

## ARNES ANATÓMICO PROFESIONAL P/ DESMALEZADORA

GT230



### CABEZAL PORTATANZA

GT135 AUTOMÁTICO UNIVERSAL



### CABEZAL PORTATANZA

GT140 C/TUERCA PROF. UNIVERSAL



### RUEDA P/ CORT. CESPED PP Y PVC

RCC125 125\*30\*10

RCC150 150\*32\*11

RCC175 175\*36\*11

RCC200 200\*41\*12

[www.engros.com.ar](http://www.engros.com.ar)



engrosdistribuidora



engros.distribuidora

Calle La Portada 3951, BERISSO 1923



221 5220273

# HERRAMIENTAS para PARQUES y Jardines

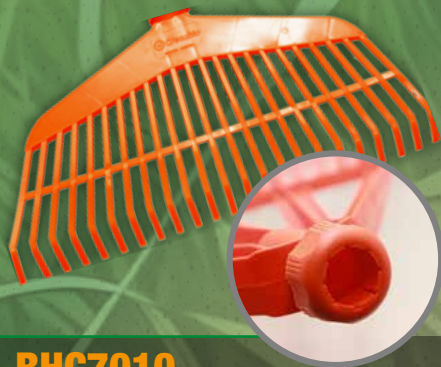

**BHC7010**  
BARRE HOJA CHICO  
REFORZADO **CRECCHIO**



**BHG7020**  
BARRE HOJA GRANDE  
REFORZADO **CRECCHIO**



**NE007**  
BARRE HOJA METÁLICO  
REGULABLE S/ CABO



**NE008**  
BARRE HOJA METÁLICO  
REGULABLE C/ CABO



**NE009**  
BARRE HOJA METÁLICO FIJO



**PJ103**  
PALITA JARDIN



**PJ104**  
RASTRILLO Y AZADA JARDIN



**PJ106**  
RASTRILLO REFORZADO  
S/ CABO 12 DIENTES



# HERRAMIENTAS para PARQUES y Jardines



**PJ120**

LANZA REF. UNIVERSAL  
PARA HIDROLAVADORA



**PJ121**

MANGUERA REF. PARA  
HIDROLAVADORA X 3 MTS.



**PJ122**

HACHA VIZCAINA  
CABO MADERA 600 GR



**PJ123**

HACHA TUMBA PROF. M/ FIBRA  
ERGONÓMICO 1800 GR



**PJ124**

TIJERA DE PODA 8'  
CORTE CLÁSICO



**PJ125**

TIJERA CORTA CERCO 12'  
CABO MADERA



**PJ127**

MACHETE DE 22'  
MANGO PLÁSTICO



**NE0015**

SERRUCHO PODA CURVO  
295 MM M/ MADERA



**SER109**

SERRUCHO PODA 350MM C/  
ESTUCHE BLISTER X1

[www.engros.com.ar](http://www.engros.com.ar)



engrosdistribuidora



engros.distribuidora

Calle La Portada 3951, BERISSO 1923



221 5220273

# HERRAMIENTAS para PARQUES y Jardines



**PJ090**  
ACOPLE RÁPIDO  
PARA MANGUERA DE 1/2



**PJ091**  
CONECTOR PICO  
ROSCA HEMBRA 1/2 Y 3/4



**PJ092**  
UNION DOBLE DE RIEGO  
PARA MANGUERA 1/2



**PJ099**  
LANZA DE RIEGO  
REGULABLE EN BLISTER



**PJ100**  
LANZA RIEGO REGULABLE CON ACOPLER RÁPIDOS  
CONECTOR 1/2 4 PCS



**PJ105**  
SAPITO REGADOR  
P/ MANGUERA DE 1/2 Y 3/4



**PJ101**  
PISTOLA DE RIEGO  
REGULABLE C/ MANGO  
ERGONÓMICO CONECTOR 1/2



**PJ102**  
PISTOLA DE RIEGO  
7 FUNCIONES C/MANGO  
ERGONÓMICO CONECTOR 1/2



# Thembu

## CERCOS



### CINTA CUBRECERCO 6,5 CM X 80 M



**TH080V**  
VERDE

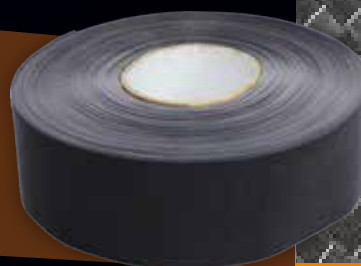

**TH080N**  
NEGRA

### MALLA P.ROMBO 11X11 | ROLLO 1.20 M x 50 M

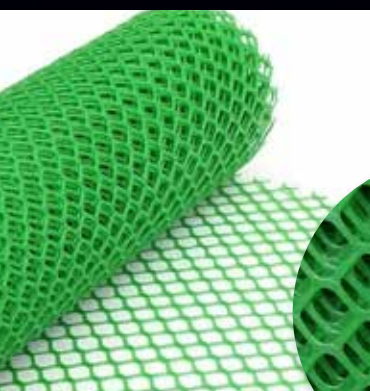

**TH011V**  
VERDE

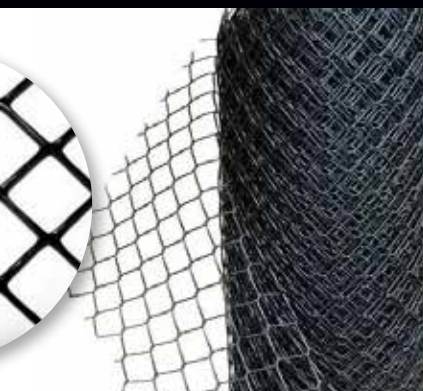
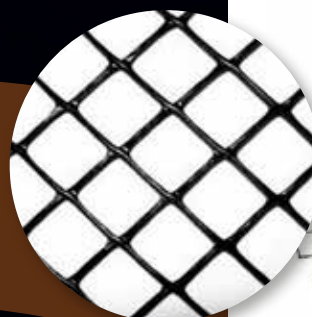
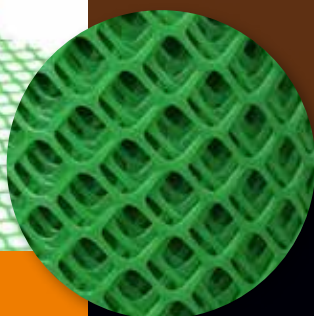

**TH011N**  
NEGRA

### RAFIA C. CERCO C/OJALES VERDE 130 GR/M2

- TH150V** 1,50 x 50M
- TH190V** 1,90 x 50M

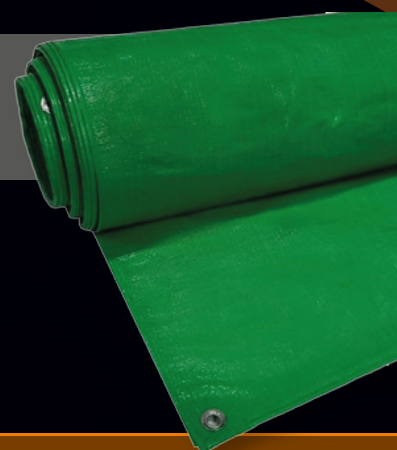

[www.engros.com.ar](http://www.engros.com.ar)



engrosdistribuidora



engros.distribuidora

Calle La Portada 3951, BERISSO 1923



221 5220273

# MALLAS electro soldadas galvanizadas y recubiertas en PVC



**PRESENTACIÓN  
COMERCIAL**

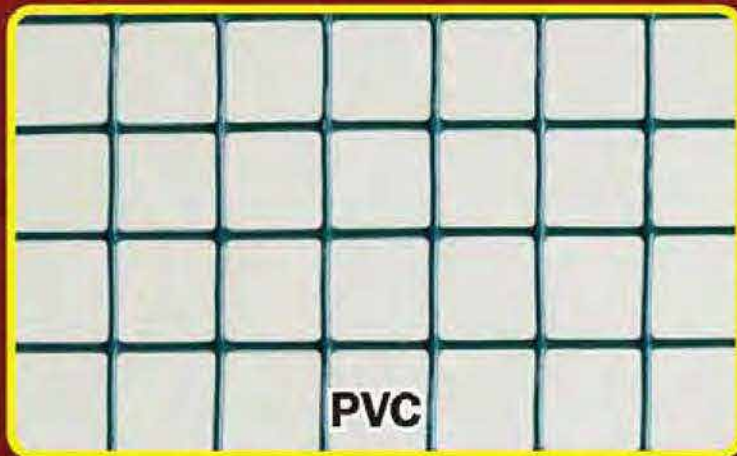

Código

DESCRIPCIÓN

999	MALLA SOLDADA GALV. 13X13 X1.0MT (1.10) X 25 MTS
1000	MALLA SOLDADA GALV. 19X19 X 1.0MT (1.25) X 25 MTS
1002	MALLA SOLDADA GALV. 25X25 X 1.0MT (1.50) X 25 MTS
1004	MALLA SOLDADA GALV. 38X38 X 1.0MT (1.50) X 25 MTS
1006	MALLA SOLDADA GALV. 50X50 X1.0MT (1.50) X 25 MTS
2886	MALLA RECUB PVC NEGRO 13X13X1MT (1.1) X 25 MTS
2888	MALLA RECUB PVC NEGRO 19X19X1MT (1.3) X 25 MTS
2887	MALLA RECUB PVC VERDE 13X13X1MT (1.1) X 25 MTS
2889	MALLA RECUB PVC VERDE 19X19X1MT (1.3) X 25 MTS



#1237 e/ 14 y 15, Berisso. | Tel. (0221) 461 2794 - ID 568\*5723

Calle La Portada 3951, BERISSO 1923

221 5220273

# TEJIDOS

HEXAGONAL  
MOSQUITERO

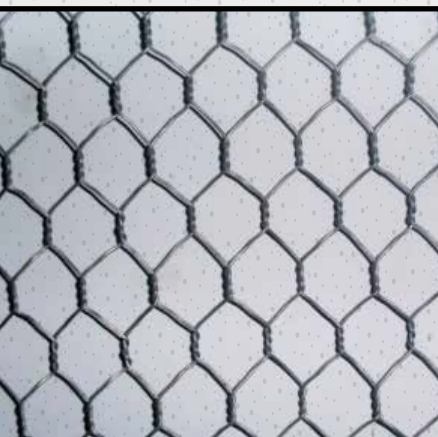

## HEXAGONAL GALVANIZADO x 30 M

<b>1262</b>	13 mm x 1 M
<b>1266</b>	19 mm x 1 M
<b>1269</b>	25 mm x 1 M



## MOSQUITERO ALUMINIO x 30 M

<b>2597</b>	0.80 M
<b>2598</b>	1.00 M
<b>2599</b>	1.20 M

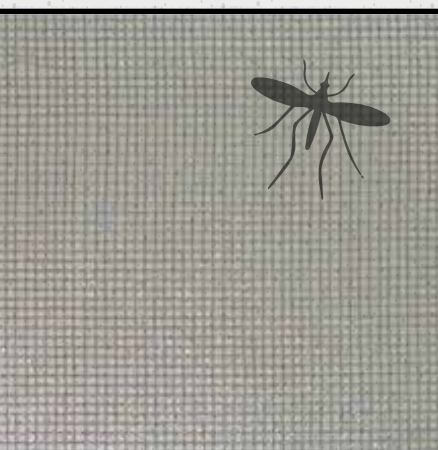

## MOSQUITERO FIBRA PVC GRIS X 50 M

<b>2600</b>	0.80 M
<b>2601</b>	1.00 M
<b>2602</b>	1.20 M



# Cabos de Pino de Primera



www.engros.com.ar | 162 Norte # 1237 e/ 14 y 15, Berisso. | Tel. (0221) 461 2794 - ID 568\*5723

## Cabo Cepillo Premium C/Rosca

Código	Descripción	Medida	Unidad
2398	CEPILLO BARRENDERO PREMIUM C/ ROSCA	1.50 mt.	24 u.
2897	CEPILLO PARRILLERO C/ ROSCA	0.60 mt.	1 u.



## Cabo Escobillón Premium C/Rosca

Cód.	Descripción	Medida	Unidad
2400	ESCOBILLON PREMIUN C/ ROSCA	1.20 mt.	24 u.
2640	ESCOBILLON PREMIUM C/ ROSCA	1.50 mt.	24 u.
2641	CABO PLUMERO LARGO C/ ROSCA	2.00 mt.	24 u.

www.engros.com.ar



engrosdistribuidora



engros.distribuidora

Calle La Portada 3951, BERISSO 1923



221 5220273



**Escobillón  
PETRA**

Cod. Caja x  
**CH0100** 12



**Escobillón  
ATENAS**

Cod. Caja x  
**CH0101** 12



**Escobillón  
ZONDA**

Cod. Caja x  
**CH0102** 12



**Escoba  
CAPRI**

Cod. Caja x  
**CH0103** 12



**Escoba  
5 HILOS**

Cod. Caja x  
**CH0104** 12



**Plumero  
de techo**

Cod. Caja x  
**CH0200** 6



**Cepillo  
lava coche**

PITA PVC 12 CM  
Cod. Caja x  
**CH0201** 12



**Cepillo  
lava camión**

PITA PVC 12 CM  
Cod. Caja x  
**CH0202** 12



**Cepillo planchita**

FIBRA SINTÉTICA 8 CM

Cod. Caja x  
**CH0203** 24



**Cepillo parrillero**

PALMIRA NATURAL 11 CM

Cod. Caja x  
**CH0204** 24



**Secador hogar**

DOBLE GOMA 40 CM

Cod. Caja x  
**CH0300** 12



**5% DESCUENTO X CAJA CERRADA**

# Baruk

# ROYCO®

# CEPILLERÍA INDUSTRIAL



## ESCOBILLONES

Baruk

5% DESCUENTO X CAJA CERRADA



### ORION

Cod. Caja x  
**CI0100** 12



### BARROCO 16 CM

Cod. Caja x  
**CI0101** 12



### MARRUECOS 24 CM

Cod. Caja x  
**CI0102** 12

## CEPILLOS

Baruk

5% DESCUENTO X CAJA CERRADA



### BARRENDERO

STRONG

Cod. Caja x  
**CI0103** 6



### ANDEN

PESADO

Cod. Caja x  
**CI0200** 60 CM 12  
**CI0201** 80 CM 12  
**CI0202** 100 CM 12



### ANDEN

PLUMADO

Cod. Caja x  
**CI0203** 60 CM 12  
**CI0204** 80 CM 12  
**CI0205** 100 CM 12

# ROYCO®

### SECADOR DE PISO

PROF. ALUMINIO BLANCO

Cod. Med.  
**CI0300** 37  
**CI0301** 52  
**CI0302** 80  
**CI0303** 100



### GOMA REPUESTO

P/ SECADOR ALUMINIO

Cod. Med.  
**CI0400** 37  
**CI0401** 52  
**CI0402** 80  
**CI0403** 100



www.engros.com.ar



engrosdistribuidora



engros.distribuidora

Calle La Portada 3951, BERISSO 1923

221 5220273